

# **SYSBEL**® **SYSBEL IS SAFETY** 安全·源自西斯贝尔



**Safety Containment Systems**



**Spill Prevention, Containment & Control**



**Special Protective Products**

# SYSBEL®

## SYSBEL IS SAFETY!

**SYSBEL** Founded in 2003, it is the world's leading provider of environmental safety and employee occupational safety solutions, focusing on the safety management of hazardous chemicals, developing and producing world-leading safe storage, leakage prevention and control and special protection products. Sysbel has more than 12,600 users and more than 180 partners around the world. Its sales area covers more than 60 countries and regions such as Japan, South Korea, Southeast Asia, Australia, the Middle East, Europe, North and South America, and its products are widely used in biomedicine, education, research, industrial manufacturing, food, electronics, automotive, environmental protection, public medical and other industries.

2003	2009	2014	2017	2019	2020	2021	2022
Safety cabinet project was established	SYSBEL established	First to get FM Fire Cabinet	"Thirteenth Five-Year" strategy Promote and support businesses	TÜV Fire Cabinet	Group operation three major brands	2.5-hour refractory cabinet rolls off the assembly line	Specialized and special new enterprise

### SYSBEL Qualification:

Shanghai "specialized and special new" enterprise  
National High-Tech Enterprise

safety

Canadian CSA

UK Sedex 4P

The "13th Five-Year" strategy promotes and supports enterprises

Expert of the Hazardous Chemicals Management Working Group of the National Safety and Health Protection Equipment Committee



**SYSBEL** has established a strict quality management system internally. From research and development to production, the series of products are strictly in accordance with the US Occupational Safety and Health Administration OSHA 29 CFR 1910.106, the National Fire Protection Association NFPA CODE30, the American National Standards Institute ANSI and other relevant regulations and standards.

**SYSBEL** has been involved in the formulation, compilation and discussion of national, local and industry standards, and actively promotes the innovation of product technologies such as chemical safe storage and leakage prevention. The company obtained the US FM safety

TUV safety

safety



### SYSBEL Values

Friendly: "In the beginning of human beings, nature is good" to treat others with a kind heart

Enterprising: devotion to work, courage to take on, continuous learning, pursuit of excellence

Cooperation: willing to share, obey the overall situation, open and win-win mentality and grow together with the team



### SYSBEL Responsibility and Mission

Only with compassion and kind can we write a poem of great love, and insisting on doing the right thing is social responsibility. For a long time, Sysbel has organized the company's volunteer team to care for orphans and widows in welfare homes, actively donated relief materials to Wangjiaba relief and disaster relief to help post-disaster reconstruction, popularized safety and epidemic prevention knowledge and distributed protective materials for workers in the free trade zone. In order to thank Sysbel for providing multiple batches of protective materials to Wuhan during the fight against the COVID-19, the Safety and Health Protection Products Committee of China Textile Business Association awarded Sysbel the honorary title of "War Epidemic Hero".



# Contents



## Safety Containment Systems SCS

Safety Storage Cabinets	8
Flammable Cabinets	11
Flammable Undercounter Cabinet	12
Drum Storage Cabinets	13
Combustible Cabinets	13
Corrosive Cabinets	14
Pesticides Cabinets	14
Toxic Cabinets	15
Waste Liquid Storage Cabinets	15
Gas Cylinder Storage Cages	16
Emergency Equipment Cabinets	16
Smart Safe Charging Cabinet	17
Waste Liquid Collection Storage Cabinet	18
Mobile safety storage box	19
Outdoor Safety Cabinet	19
Outdoor Fire Resistant Safety Storage Cabinets	20
Polyethylene Corrosive Cabinets	21
Polyethylene Corrosive Cabinets	21
Corrosive Substance Storage Cabinet	22
Oily Waste Cans	22
Biohazard Waste Cans	23
Safety Cans	23
Plunger Can	23
Cigarette Butts Receptacle	24
VOC Filter Device	24
Waste Liquid Collecting Barrel	24
Safety Cabinet Parts	25



## Spill Prevention, Containment & Control **SPCC**

Poly Spill Decks	28
Splicing Type Poly Spill Decks	28
Poly Spill Pallets	29
IBC Poly Spill Pallet	29
Steel Spill Pallets	30
Lab Spill Containment Pallets	30
Spill Control Accessories	31
Waterproof Tape	31
Absorbents	32
Heavy Durable Absorbent Mat	35
Wipes	37
Overpack Spill Kit	39
Spill Kits in Cart	42
PVC Float-Type Spill Containment Boom	43
Polyethylene Disposal Bags	43
Universal Absorbent Drip Pan	43
Portable Spill Containment Berm Pool	44
Roof Leak Diverter	44



## Special Protective Products **SPP**

Combination Unit	48
Composite self-draining eyewash shower	49
Wall Mounted Eye/Face Wash	49
Pedestal Mounted Eye/Face Wash	50
Desktop faucet emergency eyewash station	50
Drench Hose	51
Portable Eye Wash Station	51
Portable Sink/Eye Wash Sink	52
Explosion-proof electric heating eyewash shower	53
Cable Heating Emergency Shower	53
Emergency Shower Room	53
Universal First aid product series	54
Wall Mounted First Aid Kit	57
Safety Spectacles/Safety Goggles	57
Chemical label	58

## Appendix

Total Solution of the Lab Industry	59
Total Solution of Chemical Management in Industry	61
Regulation Abstract	62
<b>SYSBEL</b> Safety Cabinet Dimensions	63
<b>SYSBEL</b> Eyewash selection table (By usage environment)	64
Absorbent Material Selection Guide	65



## Safety Cabinets











Fires instantly destroy everything you have ruthlessly, causing major casualties, property damage and other consequences.

**SYSBEL** provides quality Flammable Liquid Safety Cabinets, which will help you to store hazardous chemicals safely and reduce



### Types of Chemical Safety Cabinets

In storing chemicals, colors and labels are generally used for identify dif  
identify hazardous chemicals.

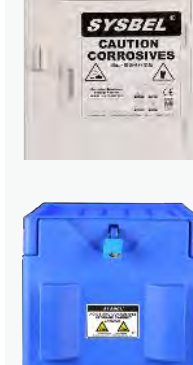
					
<p><b>Flammable Cabinets</b></p> <p>Yellow Safety Cabinet for storing amammable liquids(low and median sh point liquid<sup>1</sup>, ash point&lt;37.8°C)</p>	<p><b>Combustible Cabinets</b></p> <p>Red Safety Cabinet for storing paintings, oil and other amammable liquids(high ash point liquid<sup>2</sup>, ash point≥37.8°C)</p>	<p><b>Corrosive Cabinets</b></p> <p>Blue Safety Cabinet for storing corrosive liquids<sup>3</sup></p>	<p><b>Toxic Cabinets</b></p> <p>White Safety Cabinet for storing toxic chemicals</p>	<p><b>Pesticides Cabinets</b></p> <p>Green Safety Cabinet for storing insecticides, pesticides, disinfectors and other chemicals</p>	<p><b>Polyethylene Corrosive Cabinets</b></p> <p>Polyethylene Corrosive Cabinet for storing strong polyethylene or corrosive chemicals</p>
					

[1,2,3] Please refer to List of Hazardous Goods (GB 12268-2012) and List of Hazardous Chemicals of SAWS (State Administration of Work Safety)

\* OSHA

\*\*Please refer to P49 for types of Safety Cabinets.

# How to choose safety storage cabinets?

## Storage Containers

Choose cabinets according to the types and volumes

Confirm the containers are as below: safety cans, oily drums of less than 55Gal, small volume of coating containers, 4L bottles, aerosol containers or smaller bottles. All storage containers must be airtight.



## Storage Volume

Confirm the volume of needed safety cabinet

Choose cabinets according to your needed volume. Bigger cabinets offer more storage space. SYSBEL Safety Cabinets have 11 different volumes, namely 4Gal, 12Gal, 22Gal, 30Gal, 45Gal, 54Gal, 55Gal, 60Gal, 90Gal, 110 Gal and 120Gal, you can choose the best type based on storage space and volume.

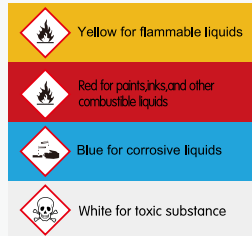

According to U.S. industry usage habits

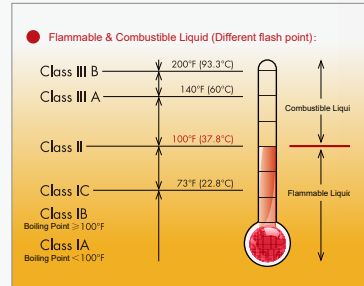

**Explosive**  
(divisions 1.1-1.4);  
Self-reactive substances;  
Organic peroxides.



**Flammable**  
Flammable substances;  
Pyrophoric substances;  
Self-heating substances;  
Substances that emit flammable  
gases in contact with water



**Oxidising**  
Oxidising substances.



**Corrosive**  
Corrosive to metals;  
Skin corrosion;  
Serious eye damage.



**Toxic**  
Acute toxicity  
(oral,dermal,inhalation)



**Compressed Gas**  
Compressed, liquefied,  
and dissolved gases.



**Irritant**  
Eye or skin irritation;  
Skin sensitization;  
Respiratory tract irritation;  
Narcotic effects.



**Health Hazard**  
Aspiration hazard,Respiratory  
sensitization,Carcinogenicity,  
Germ cell mutagenicity,  
Reproductive toxicity,Specific  
target organ toxicity.



**Environmental  
Hazard**  
Acute or chronic hazards to  
the aquatic environment.

\* GHS by United Nations

Commonly used hazardous chemicals storage contraindication table			Serial number	
Hazardous Chemicals	Explosives	ignition equipment	1	1
		detonating equipment	2	x 2
		Explosives and Explosives	3	x x 3
		other explosives	4	△ x x 4
	Oxidizer	organic oxidant	5	x x x x 5
		nitrite, chlorite, hypochlorite 1	6	△ △ △ △ △ x 6
		other inorganic oxidants2	7	△ △ △ △ △ x x 7
	Compressed	highly toxic	8	x x x x x x 8
			9	△ x x △ x △ △ 9
	Gases	combustion	10	△ x x △ 10
		not combustible	11	x x 11
	Spontaneous Combustion	Level 1	12	△ x x x x △ △ x x x 12
		Level 2	13	x x △ x △ △ x 13
		Items that burn in contact with water	14	x x x △ △ △ △ △ △ x 14
		15	△ x x x x △ x x x x △ 15	
		16	x x △ x △ △ x x x 16	
Poison	cyanide	17	△ △ △ 17	
	other poisons	18	△ △ 18	
Corrosive	Acid corrosion	bromine	19	△ x x x x △ x △ △ △ △ x △ 19
		hydrogen peroxide	20	△ x x △ △ △ △ △ x △ △ △ △ x △ 20
		nitric acid, fuming nitric acid, sulfuric acid, oleum, chlorosulfonic acid	21	△ x x x x x 1) x x △ △ x x △ △ △ △ △ △ △ 21
	other acid corrosive items	22	△ x x △ △ △ △ △ △ △ △ △ △ x △ △ △ △ 22	
	Alkaline and other	quicklime, bleaching powder	23	△ △ △ △ △ △ △ △ △ △ △ △ △ △ △ △ △ △ 23
others		24	△ x 24	

Note:  
 1 No allocation symbol indicates that allocation is possible.  
 2 △ Indicates that it can be stored and isolated at least 2m when stacking.  
 3 x Indicates that it cannot be allocated.  
 4 When there are notes, follow the notes.  
 1) Except for nitrates (such as sodium nitrate, potassium nitrate, ammonium nitrate, etc.), which can be co-existed with nitric acid and fuming nitric acid, in other cases, co-existence is not allowed.  
 2) Inorganic oxidants shall not be stored with soft powdery combustibles (such as coal powder, coke powder, carbon ink, sugar, starch, sawdust, etc.).  
 Quote from: GB Standard 15603-1995



## SYSBEL—EN Safety Storage Cabinets

In the most severe EN1361-1 fire resistance test, after 90 minutes of burning at a high temperature of 1006°C, the maximum temperature of the 15 temperature measuring points in the cabinet was far lower than the standard requirements, meeting the EU standard Various standards and testing requirements of EN14470-1:2004.



## TÜV Certification

TÜV is Germany's largest product safety and quality certification body, and is also an inspection body recognized by the German government, with a 145-year reputation in Germany and Europe. As the world's leading provider of testing technology and services, the Rhein Group has a global service network. Since its establishment in 1872, the Rhein Group has always been committed to the challenges arising from the interaction of humans, the environment and technology and provides corresponding solutions.

For decades, TÜV has won the trust of countless people and enjoys a high reputation all over the world, which means that the products have passed the inspection of neutral institutions, and their safety and quality are trustworthy. A product certified by TÜV means that its performance is reliable and can reduce the asset risk of customers; at the same time, it means that the products used by customers can meet the requirements of local standards.



## Safety Storage Cabinets

- The cabinet is made of high-strength steel plate. The surface of the cabinet body is electrostatically sprayed with orange-stripe molding powder, which is easy to clean, scratch-resistant, impact-resistant and durable. Multi-layer gypsum board insulation is used in the cabinet compartment to achieve the purpose of
- In normal use, the semi-automatic door can be manually opened or closed; if a occurs, the temperature reaches 122°F (50°C), the built-in fuse connection system works, and the opening door will be automatically closed to protect the storage of items in the cabinet. The cabinet door has a damping screw to adjust the size of the door force of the switch.
- The baf e plate of ventilation holes automatically close at 158°F (70°C) in a re environment. The ventilation system can be connected with an exhaust pipe or a
- When occurs, the special heat-sensitive materials provided in the door joints and all joints will automatically expand and the gaps to ensure that the interior of the cabinet is sealed.
- Each door has a separate cylindrical lock to effectively prevent unauthorized use. The door is with warning labels in multiple languages. In the
- The detachable bottom leakage groove is equipped with guide plate on the three sides, which is used together with the perforated inserts to effectively catch the The container is placed on the perforated inserts to avoid being soaked in the bottom leaking groove.
- It is 3 standard adjustable steel laminates, with an adjustable spacing of 32mm for each interval, the load capacity of the laminate is 75KG. The turn-up height of the laminate is 30mm, which prevents the small container from accidentally slipping off.
- The bottom of the cabinet is provided with adjustable leveling feet, which can balance the cabinet even on uneven surfaces.
- It is equipped with electrostatic grounding conductive port to facilitate the connection of static grounding conductors.
- The safety cabinet complies with EN 14470-1 and complies with NFPA 30 and OSHA regulations. Among them, SE830450 passed TÜV independent test and obtained



### Safety Storage Cabinets

Fire resistance (min)	Door Type	Color	Certification	Ext dimension (H×W×D/cm)	Packing dimension (H×W×D/cm)	Standard adjustable laminate (block)	Load bearing of laminate (Kg)	Leakage tank capacity at the bottom (L)	Outlet connection diameter (mm)	Store a single largest container(L)	Volume (Gal/L)	Model
30	Double Door/Self-close	Yellow	EN14470-1	204×116×62.5	218×123×74	3	75	37	100	33	45/170	SE830450
60	Single Door/Self-close		EN14470-1	204×60×62.5	218×67×74	3	75	18.5	100	16.5	23/87	SE860230
90	Single Door/Self-close		EN14470-1	204×60×62.5	218×67×74	3	75	18.5	100	16.5	23/87	SE890230
90	Double Door/Self-close		EN14470-1	204×90×62.5	218×97×74	3	75	30	100	27	30/114	SE490300
90	Double Door/Self-close		EN14470-1	204×116×62.5	218×123×74	3	75	37	100	33	45/170	SE890450

### Undercounter Cabinet

90	Single Door/Self-close	Yellow	EN14470-1	61.5×56×52	75.5×63×63.5	1	75	11	75	9.5	10/38	SE490100
90	Single Door/Self-close		EN14470-1	75×60×52	89×67×63.5	1	75	12.5	75	11	12/45	SE490120
90	Double Door/Self-close		EN14470-1	61.5×86×52	75.5×93×63.5	1	75	19	75	17	17/64	SE490170
90	Double Door/Self-close		EN14470-1	63×110×59	77×117×70.5	1	75	32	75	28.5	19/72	SE490190

### Moving Wheel

Name	Loading Capacity	Adjustable Cabinets	Model	Description
Moving wheel	600kg	SE490300, SE830450, SE890450	WAB005	Convenient for the cabinet to move indoors and can pass through normal room doors

\*Selection tips: The colors of this series of products are yellow, blue, white, etc. Only the colors of the cabinet doors are different. The yellow series SKU is shown in the pictures above. For the blue series, please add "-B" after the SKU in the table above. White series Please add "-W" after the SKU in the table above.



## SYSBEL® —Flammable Liquid Chemical Safety Cabinets

### FM Approvals

SYSBEL gets the Approval certificate of various capacities of steel safety cabinet issued by FM Approvals!

One of the Major Causes for fires is improper storage and handling of flammable liquids and chemicals. Fire will instantly destroy everything you have ruthlessly. It will cause huge enterprise property loss and security threats to employees, of course, and also induce expensive social cost, time cost...

SYSBEL® brand steel safety cabinets get Approval certificate by FM Approvals. It represents not only the quality of our tireless pursuit of product safety, but also stands for the FM product's quality level "best product by the highest standards". We hope SYSBEL® brand steel safety cabinets which pass the most rigorous testing, can bring the most reliable protection for your storage and property security.



\* [www.approvalguide.com](http://www.approvalguide.com)  
Complete the registration to self-check



High quality welded steel

Adjustable shelves with anti-leakage design

Shelf bracket welded on both sides of cabinet

Unleaded coating with polish surface, which is corrosion and moisture proof

5.3cm sump to prevent spill

Fireproofing vents to effectively reduce the concentration of volatile substances, and prevent

proof shelves to avoid chemical leakage by accident.

Double fireproof steel panel and the insulate temperature space between the 2 panel is 38mm

The cabinet has three-point linkage lock, and the door can open 180°

Safety locking devices, double-lock management in line with Hazardous chemicals Control Ordinance.

The label material is made of high quality reflective material to improve the safety of the cabinets in the weak light area



FM Approved and CE Approved, Compliant with FM Approval Standard for Flammable Liquid Storage Cabinets (FM Approval Standard 6050), OSHA OSHA 29 CFR 1910.106 and National Fire Protection Association (NFPA) NFPA CODE 30 Specifications, China's State Administration of Work Safety "Regulations on the Safety Management of Hazardous Chemicals" 1, GB 24820-2009 "General Technical Conditions for Laboratory Furniture"



Adjustable shelves: adjustable among every full use of space



Fireproofing ventilation hole: at both sides of the cabinet, one on the top and the other on the bottom



SYSTEMEX Three-point linkage lock: make lock safer; Flush paddle handle offers easy operation and save space



MSDS management: the implementation of



The three-point bullets: anti-static design structure



Anti-Static Device: conductor grip combine the equipment with the cabinet to conduct the static to earth, thus to prevent



Self closing device (self-closing door product): comes with self closing system, it can automatically close the metal door under the fuse



blackouts, the location of the cabinet can be quickly locked by lighting

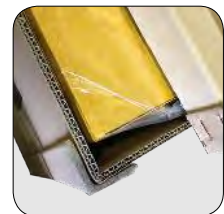

Thickening packing: The corner support is strengthened and packed in thick box to facilitate transportation and ensure the safety of product transportation

[1] Please refer to List of Hazardous Goods (GB 12268) and List of Hazardous Chemicals of SAWS (State Administration of work safety)  
 \*\* Please refer to P49 for types of Safety Cabinets

## Flammable Cabinets

SYSBEL

&lt;37.8°C),



## Flammable Cabinets

Volume (Gal/L)	Certification	Door type	Ext dimension (H×W×D/cm)	Packing dimension (H×W×D/cm)	Adjustable Shelves(Pcs)	Shelf Loading Weight(Kgs.)	Model (Manual)	Model (Self-close)	Adjustable Shelve	Remark
4/15	CE	Single	56x43x43	59x50x50	1	50	WA810040	WA810041	WAL040	-
15/57	CE	Three	180x43x46	194x49.6x52.6	3	50	WA031050	-	-	Color optional (yellow/blue/white)
30/114	CE	Six	180x86x46	194x92.6x52.6	6	50	WA032050	-	-	
45/170	CE	Nine	180x129x46	194x135.6x52.6	9	50	WA033050	-	-	
10/38	CE	Single	64x59x60	78x66x67	1	50	WA810100	-	WAL010	-
12/45	FM, CE	Single	89x59x46	103x66x53	1	50	WA810120	WA810121	WAL012	-
12/45	FM, CE	Double	46x109x46	64x116x52.5	-	-	WA3810120	-	WAL03045	EX Piggyback
12/45	CE, GA	Single	89x59x46	103x66x53	1	50	WA810122	-	WAL012	GAPasswordlock
15/57	FM, CE	Single	112x59x46	126x66x53	1	50	WA810150	-	WAL012	-
17/64	FM, CE	Double	61x109x46	75x116x52.5	1	100	WA810170	-	WAL03045	Wall Mounted
17/64	FM, CE	Double	61x109x46	75x116x52.5	1	100	WA3810170	-	WAL03045	EX Piggyback
22/83	FM, CE	Single	165x60x46	179x67x53	3	50	WA810220	WA810221	WAL022	-
30/114	FM, CE	Double	112x109x46	126x116x53	1	100	WA810300	WA810301	WAL03045	-
30/114	CE	Double	112x109x55	126x116x62	1	100	WA810300C	-	-	Corner
45/170	FM, CE	Double	165x109x46	179x116x53	2	100	WA810450	WA810451	WAL03045	-
45/170	CE, GA	Double	165x109x46	179x116x53	2	100	WA810452	-	WAL03045	GAPasswordlock
53/200	CE	Double	180x109x46	194x116x53	3	100	WA810530	-	WAL03045	-
54/204	FM, CE	Single	165x60x87	179x67x94	3	100	WA810540	WA810541	WAL054	-
60/227	FM, CE	Double	165x86x86	179x93x93	2	100	WA810600	WA810601	WAL060	-
90/340	FM, CE	Double	165x109x86	179x116x93	2	100	WA810860	WA810861	WAL090	-

## Flammable Safety Storage Undercounter Cabinet

The structural design of SYSBEL' cabinet meets the requirements of FM6050 standard, OSHA 29 CFR 1910.106 of the US Occupational Safety and Health Administration and the NFPA the National Fire Protection Association of the United States. resistance, which can well isolate and protect the dangerous chemicals in it in the event of

1. The rear of the cabinet is equipped with a ventilation device, which is convenient to be placed under the fume hood, and the rear is externally ventilated to effectively reduce the
2. Three-point interlocking reduces friction or mechanical sparks and reduces static electricity accumulation.

provisions of China's "Hazardous Chemical Safety Management Regulations".

4. More than 2" (51mm) deep leakage tank prevents leakage of the liquid from over owing,
5. The bottom skirting line is designed to facilitate the experimental operation of personnel and conform to human mechanics.
- 6.

The laminate can be adjusted according to the modulus of 7.6cm to increase the space utilization rate.

7. Optionally install FM-approved anti-static device to introduce static charge into the



WA0810080



WA0810100



WA0810140

mobile

stationary



WA0810180



WA0810190



WA0810230



WA0810080T

drawer type

### Flammable Safety Storage Undercounter Cabinet

Style	Volume (Gal/L)	Door type	Ext dimension (H×W×D/cm)	Packing dimension (H×W×D/cm)	Adjustable Shelves(Pcs)	Shelf Loading Weight(Kgs.)	Color	Model	Adapt to fume hood specifications (wide/mm)
mobile	8/30	Single	61.5x56x52	75.5x63x59	1	50	Yellow	WA0810080	1200
	10/38	Double	61.5x71x52	75.5x78x59	1			WA0810100	1500
	14/53	Double	61.5x86x52	75.5x93x59	1			WA0810140	1800
stationary	18/68	Double	79x75x56	93x82x63	1	50	Yellow	WA0810180	1500
	19/72	Double	91x76x57	105x85x63	1			WA0810190	1500
	23/87	Double	89x89x55	103x96x65	1			WA0810230	1800
drawer type	8/30	Single	61.5x56x52	75.5x63x59	1			WA0810080T	1200

\*Cabinet color can be customized

## Drum Storage Cabinets

**SYSBEL** drum storage cabinets.  
set of slippery course to guide the oil drum bracket cart in and out.

A CODE 30. Form a complete



WA811100



WA810550



WA810115

### Drum Storage Cabinets

Volume (Gal/L)	Certification	Door type	Ext dimension (H×W×D/cm)	Packing dimension (H×W×D/cm)	Adjustable Shelves(Pcs)	Shelf Loading Weight(Kgs.)	Model	Adjustable Shelf
55/207	CE	Double	165x86x86	179x93x93	1	100	WA810550	-
110/415	CE	Double	165x150x86	179x157x95	1	100	WA811100	-
115/434	CE	Double	165x150x86	179x157x95	2 (Left) 1 (Right)	100	WA810115	WAL115L

## Combustible Cabinets

**SYSBEL**  
point≥37.8°C), Suitable for coating, printing, furniture, automobile and other industries.



### Combustible Cabinets

Volume (Gal/L)	Certification	Door type	Ext dimension (H×W×D/cm)	Packing dimension (H×W×D/cm)	Adjustable Shelves(Pcs)	Shelf Loading Weight(Kgs.)	Model	Adjustable Shelf
4/15	CE	Single	56x43x43	59x50x50	1	50	WA810040R	WAL040
12/45	FM, CE	Single	89x59x46	103x66x53	1	50	WA810120R	WAL012
30/114	FM, CE	Double	112x109x46	126x116x53	1	100	WA810300R	WAL03045
45/170	FM, CE	Double	165x109x46	179x116x53	2	100	WA810450R	WAL03045
60/227	FM, CE	Double	165x86x86	179x93x93	2	100	WA810600R	WAL060
90/340	FM, CE	Double	165x109x86	179x116x93	2	100	WA810860R	WAL090

## Corrosive Cabinets

**SYSBEL** Corrosive Cabinets for storing corrosive liquids, Apply to the LABS of colleges and universities, research institutes, etc.



### Corrosive Cabinets

Volume (Gal/L)	Certification	Door type	Ext dimension (H×W×D/cm)	Packing dimension (H×W×D/cm)	Adjustable Shelves(Pcs)	Shelf Loading Weight(Kgs.)	Model	Adjustable Shelf
4/15	CE	Single	56x43x43	59x50x50	1	50	WA810040B	WAL040
12/45	FM, CE	Single	89x59x46	103x66x53	1	50	WA810120B	WAL012
22/83	FM, CE	Single	165x60x46	179x67x53	3	50	WA810220B	WAL022
30/114	FM, CE	Double	112x109x46	126x116x53	1	100	WA810300B	WAL03045
45/170	FM, CE	Double	165x109x46	179x116x53	2	100	WA810450B	WAL03045
60/227	FM, CE	Double	165x86x86	179x93x93	2	100	WA810600B	WAL060
90/340	FM, CE	Double	165x109x86	179x116x93	2	100	WA810860B	WAL090

## Pesticides Cabinets

**SYSBEL** Safety Cabinets for Pesticides for storing insecticides, pesticides, disinfectors and other chemicals. Suitable for lawn care, golf course, farms, parks, amusement parks and other places.



### Pesticides Cabinets

Volume (Gal/L)	Certification	Door type	Ext dimension (H×W×D/cm)	Packing dimension (H×W×D/cm)	Adjustable Shelves(Pcs)	Shelf Loading Weight(Kgs.)	Model	Adjustable Shelf
12/45	FM, CE	Single	89x59x46	103x66x53	1	50	WA810120G	WAL012
45/170	FM, CE	Double	165x109x46	179x116x53	2	100	WA810450G	WAL03045

## Toxic Cabinets

**SYSBEL** Toxic Cabinets for storing toxic chemicals, Widely used in chemical plants, laboratory in colleges and universities, research institutes, etc.



## Combustible Cabinets

Volume (Gal/L)	Certification	Door type	Ext dimension (H×W×D/cm)	Packing dimension (H×W×D/cm)	Adjustable Shelves(Pcs)	Shelf Loading Weight(Kgs.)	Model	Adjustable Shelve
12/45	FM, CE	Single	89x59x46	103x66x53	1	50	WA810120W	WAL012
12/45	CE, GA	Single	89x59x46	103x66x53	1	50	WA810122W	WAL012
30/114	FM, CE	Double	112x109x46	126x116x53	1	100	WA810300W	WAL03045
45/170	FM, CE	Double	165x109x46	179x116x53	2	100	WA810450W	WAL03045
45/170	CE, GA	Double	165x109x46	179x116x53	2	100	WA810455W	WAL03045

## Waste Liquid Storage Cabinets

The combination lock waste liquid storage cabinet is based on the design of a standard safety cabinet, which has the same

PP board, which is resistant to strong acid, alkali and excellent characteristics with corrosion resistance; The overall design of the PP

of the user; The conventional 6L, 10L, 20L, and other models of waste liquid barrels on the market can be placed in the cabinet; The combination lock waste liquid storage cabinet adopts electronic combination lock + mechanical lock, double lock management to effectively achieve the control, safety, anti-theft, and anti-collision of hazardous chemicals, in line with industry standards GA1511-2018.



## Waste Liquid Storage Cabinets (Combination Lock)

Volume (Gal/L)	Certification	Door Type	Color	Ext dimension (H×W×D/cm)	Packing dimension (H×W×D/cm)	lock	Adjustable Shelves (Pcs)	Shelf Loading Weight(Kgs)	Model	Adjustable Shelve
12/45	CE, GA	Single	Blue	89x59x46	103x66x53	Double GA mechanical lock	1	30	WA810125B	-
30/114	CE, GA	Double		112x109x46	126x116x53		1	30	WA810305B	ACPL030
45/170	CE, GA	Double		165x109x46	179x116x53		2	30	WA810455B	ACPL030
45/170	CE, GA	Double		165x109x46	179x116x53	Password GA lock	2	30	WA810453B	ACPL030



## Gas Cylinder Storage Cages

**SYSBEL** offers a comprehensive range of Gas Cylinder Storage Cages, which are available in horizontal, vertical and horizontal & vertical styles to hold LPGs and gas cylinders. Whether it is for storing LPGs, Gas Cylinders or a mixture, we have a solution for you. These rugged gas cylinder storage cages protect from theft and unauthorized access. They securely and efficiently store cylinders in industrial or commercial outdoor or indoor with highly visible flammable signs. And meet NFPA 58 for LPG storage and OSHA 1910.110 regulations.



### Gas Cylinder Storage Cages

Cylinder Type	Certification	Position	Capacities	Racks	Product Size (H*W*D/cm)	Model
LPG	CE	Horizontal	4	1	96x76x76	<b>WA710204</b>
			8	3	180x76x76	<b>WA710208</b>
			16	6	180x152x76	<b>WA710216</b>
Compressed Gas	CE	Vertical	9	-	180x76x76	<b>WA710309</b>
			18	-	180x152x76	<b>WA710318</b>
LPG & Compressed Gas	CE	8 horizontal and 9 vertical cylinder		3	180x152x76	<b>WA710589</b>

## Emergency Equipment Cabinets

It is mainly used for the storage of personal protective equipments or emergency equipments, such as helmets, protective glasses, equipment cabinet is also widely used to store absorbents, chemical suits, chemical boots, protective glasses, protective goggles and other emergency equipments.



Accessories are subject to the actual product

### Emergency Equipment Cabinet (PPE Cabinet)

Color	Details	Volume (Gal/L)	Certification	Ext dimension (H*W*D/cm)	Packing dimension (H*W*D/cm)	Adjustable Shelves (Pcs)	Model
Gray	With the Windows	45/170	CE	180X90X45	192X96X52	3	<b>WA920450</b>
Gray	Without Windows	45/170	CE	180X90X45	192X96X52	3	<b>WA930450</b>
Yellow	With the Windows	45/170	CE	180X90X45	192X96X52	3	<b>WA920450Y</b>
Yellow	Without Windows	45/170	CE	180X90X45	192X96X52	3	<b>WA930450Y</b>

## Smart Safe Charging Cabinet

**SYSBEL** The intelligent safety charging cabinet produced is suitable for the storage and charging of electric tool batteries. The product strictly follows American Occupational Safety and Health Association OSHA 1910.101 and the American Fire Protection Association NFPA 58 regulations.



lithium batteries for mainstream power tools on the market



Frequency conversion exhaust, more



Lightning protection industrial socket, more stable and safer



Imported sensing system, more accurate temperature and humidity



High-sensitivity smoke sense, rapid sensing and rapid alarm



Door control induction, humanized energy-saving design



Ventilation, leaks, a lot of them



disasters



Well-known brand components, stable and reliable

### Smart Safe Charging Cabinet

Volume (Gal/L)	Door Type	Color	Certification	Ext dimension (H×W×D/cm)	Packing dimension (H×W×D/cm)	Standard PDU industrial socket (pcs)	Adjustable Shelves (Pcs)	Shelf Loading Weight(Kgs)	Operating Voltage	Model
45/170	Double	frame: black door panel: blue	CE	189×109×46	203×116×55.5	4 (32 in total)	4	75	AC 220V/50Hz	WA810454

## Waste Liquid Collection Storage Cabinet

1. The cabinet is a double-layer steel structure, which meets the requirements of FM standards, OSHA 29 CFR 1910.106 of the US Occupational Safety and Health Administration and the NFPA Association of the United States.
2. The cabinet is equipped with two ventilation devices to ef extinguishing devices can also be selected).
3. The surface is treated with epoxy resin powder coating, bright, dust-proof, rust-proof and anti-corrosion.
4. The three-point interlock of the cabinet door reduces friction or mechanical sparks and reduces the accumulation of static electricity.
5. It can be equipped with a safety padlock to realize double-lock management, which is in line with China's "Regulations on the Safety Management of Hazardous Chemicals".
6. The bottom is equipped with a polyethylene laboratory tray, which can effectively prevent liquid leakage and meet the leakage standards.
7. Equipped with Sisbell 20L HDPE waste liquid barrel as standard, which can effectively store and transfer waste liquid.
8. Equipped with a battery level alarm as standard, with its own power supply, when the waste liquid reaches the set value, an audible and visual alarm will be generated.
9. Both sides of the top are equipped with PP cup grooves, which can effectively collect waste liquid and avoid corrosion. The middle is equipped with PE trays for storing small protective products.
10. The bottom is equipped with a brake universal wheel to ensure that the equipment is easy to move, and the right side is equipped with a handle for easy transportation.
11. The chemical compatibility table is posted on the top, referring to this table can effectively avoid the harm caused by the mixing of incompatible chemicals.
12. Optional FM-approved anti-static device.



### Waste Liquid Collection Storage Cabinet

Door Type	Color	Ext dimension (H×W×D/cm)	Packing dimension (H×W×D/cm)	Number of barrels	Model
Double	blue	88.8x86x60	105x93x67	2x20L	WA950230B

## Mobile safety storage box

A large number of production tools are needed on production sites or in factories, such as large electric welding machines, pipe wrench, hammers and other tools. Smaller tools such as adjustable wrench, spanner, screwdriver, etc. The disorder of these tools caused by the negligence of production workers may results in relatively messy at the construction site. In

to the problem of safe storage of tools.

CE

CE认证



WA940101



WA940102

universal wheels  
for brakedirectional  
wheels

WAW0125 (optional)

### Mobile safety storage box

Certification	Colour	Ext dimension (H×W×D/cm)	Packing dimension (H×W×D/cm)	Model
CE	yellow	69.9×121.9×61	72×125×64	<b>WA940101</b>
CE	orange	85×121.9×76.4	87.5×125×79	<b>WA940102</b>

## Outdoor Safety Cabinet

1. With weatherproof structure design, the cabinet can be placed outdoors, providing a convenient and safe storage
2. The special door lock protective cover can effectively prevent rain and dust from corroding the lock. Coated with outdoor resin powder on the surface of the cabinet, it is also resistant to UV and rain corrosion.
3. The forklift slot on the bottom of the cabinet makes it easy to transport.
4. In order to effectively ensure the stability of the cabinet in bad weather expansion bolts at the four corners.
5. Ventilation devices on both sides can ef
6. The double safety padlock managed by double staff is in accord with Regulations on the Safety Administration of Dangerous Chemicals.
7. The 2"
8. Anti-spill shelves can prevent the leakage of chemicals and can be adjusted as needed.
9. In strict accordance with OSHA anti- static device.
10. With continuous piano hinges, the door can be opened and closed smoothly.

CE

CE认证



WA510024



WA510025

### Outdoor Safety Cabinet

Capacity (gallon/L)	Certification	Colour	Type of doors	Ext dimension (H×W×D/cm)	Packing dimension (H×W×D/cm)	Adjustable shelf (piece)	Loading of the shelf (Kgs.)	Model
45/170	CE	Gray	Double door/ Manual	180×109×57	194×116×63	2	100	<b>WA510024</b>
115/434	CE	Gray		180×150×98.5	194×157×106	2	100	<b>WA510025</b>

\*Cabinet color yellow optional

\* WA510025 is compatible with WADR001 roller for storing oil and chemical barrels



## Outdoor Fire Resistant Safety Storage Cabinets

We all know that hazardous chemicals are generally flammable, explosive and toxic, and their storage before their destruction or leakage of toxic chemicals, endangering people's lives and property. From the perspective of safe storage, the hazardous chemicals stored indoors are mostly small-capacity and high-risk. Hazardous chemicals such as large containers and oil drums will occupy a lot of indoor space, and the transportation of hazardous chemicals is not convenient. In addition, most A warehouses, so the more approach is to build a rainproof shelter outdoors, and store hazardous chemical raw materials or hazardous wastes on the other departments. chemicals and hazardous waste outdoors, thereby reducing the safety risk factor and saving valuable indoor space.

- The whole cabinet is tested for fire resistance according to GB/T 9978.1-2008 "Fire resistance test methods for building components - Part 1: General requirements". The fire resistance time of the whole cabinet reaches 2.5h, and the internal temperature rise of the cabinet within 2.5h is not higher than 180°C;
- The cabinet adopts a double-layer steel plate structure, and the compartment is filled with fire-resistant materials, which has excellent fire resistance;
- The cabinet adopts electrostatic spraying method, sprayed with outdoor special plastic powder, which can effectively resist the invasion of ultraviolet rays and rain, and has better weather resistance;
- The bottom of the cabinet is provided with a drain tank, which can effectively deal with the accumulated liquid in the cabinet, which meets the standard requirements of Part 264 of the EPA 40 CFR 264, 175 Environmental Protection Law;
- The base of the cabinet is welded with high-strength channel steel, with a slot, and can be equipped with a forklift to facilitate the movement of the cabinet;
- The four corners of the cabinet are set with stainless steel expansion bolts and the ground for good grounding, which effectively ensures the stability of the cabinet in bad weather;
- It is equipped with a ventilation and ventilation device as standard, and is equipped with a UL certified flame arrester. When the ambient temperature reaches 70 °C, the ventilation opening will be automatically closed. Install stainless steel insect-proof rodent net inside the vent;
- The steel hot-dip galvanized grille is equipped in the cabinet, which can effectively carry heavy objects such as oil drums;
- The cabinet is in strict accordance with OSHA standards and the cabinet is provided with an electrostatic grounding conduction port, which is convenient for installing electrostatic connecting wires;
- Comply with EPA, NFPA 30 and NFPA 1 requirements;
- 15-year limited warranty for the whole cabinet.



Shelf Bracket

Steel Anti-Slip Ramp



Effectively carry heavy objects such as oil drums



Standard ventilation With UL



prominent label



Spray outdoor special plastic powder Effective against UV rays and rain

WA530021

WA530022

WA530023

WA530024

WA530025

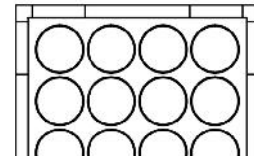
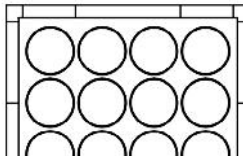
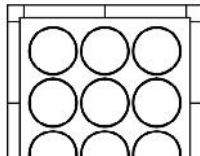
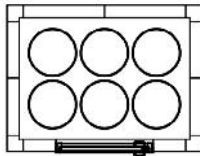
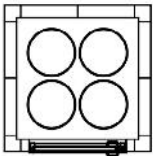

\* Take a 55-gallon oil drum as an example

### Outdoor Fire Resistant Safety Storage Cabinets

Type of doors	Fire-proof level(h)	The whole cabinet fire resistance test standard	Ext dimension (H×W×D/cm)	Packing dimension (H×W×D/cm)	Product liability insurance (10,000 yuan)	Leakage volume (L)	Capacity (55 gallon drum)	ventilation device	color	Carrying capacity	Model
Single Open/ Class A Fire Door	2.5	GB/T 9978.1-2008	250*180*180	200*150*150	1000	400	4	standard	gray	1000Kg/m <sup>2</sup>	WA530021
			250*240*180	200*210*150		550	6				WA530022
			250*240*240	200*210*210		800	9				WA530023
			250*300*240	200*280*210		1000	12				WA530024
			250*300*300	200*280*280		1300	16				WA530025

\* Optional steel anti-skid ramps and shelf brackets

## Polyethylene Corrosive Cabinets

**SYSBEL** Polyethylene corrosive cabinet, with seamless structure, ensure almost no leakage, and excellent performance of corrosion resistance and secondary leakage prevention and control. Double padlocks help to achieve double-person lock management, which is in line with EPA264.175 of the U.S. EPA, OSHA29CFR1910.1450 of the U.S. OSHA and Chinese Management of Hazardous Chemicals Ordinance (December 1, 2011 edition). On the cabinet doors, there are acidic and corrosive chemical warning labels to give your chemical storage management double guarantee.



Obtained CE in line with the US Environmental Protection Agency (EPA) EPA 264.175, the US Occupational Safety and Health Administration (OSHA) OSHA 29 CFR 1910.1450, and the China National Work Safety Administration "Hazardous Chemical Safety Management Regulations"



ACP80001



ACP80002

### Polyethylene Corrosive Cabinets

Volume (Gal/L)	Number of Doors and Style	Ext dimension (H×W×D/cm)	Packing dimension (H×W×D/cm)	Adjustable Shelves (Pcs)	Volume of Bottom Leakage(Gal/L)	Shelf Loading Weight(Kgs.)	Model
4/15	One/Desktop	49×41×36	53×43.5×42	1	1.79/6.8	20	ACP80001
22/83	Two/Undercounter	89×90.5×54.4	91.5×93×66.5	4	3.17/12	20	ACP80002

Remarks: The working area of the workbench at the top of the cabinet: 36.4x27.2 (ACP80001, LxW/cm) 83.3x46.7 (ACP80002, LxW/cm)  
 Effective use area of laminate: 26.4x35.6 (ACP80001, L1xD1/cm) 37.7x43.6 (ACP80002, L3xD3/cm)  
 Effective use area of the drain tank: 37x26 (ACP80001, L2xD2/cm) 47.2x43.5 (ACP80002, L4xD4/cm)

## Polyethylene Corrosive Cabinets

This product is made of polyethylene material, the cabinet structure is formed once, the corrosion resistance performance and the secondary leakage prevention and control performance is superior, the seamless structure guarantees can be not easy to leak, the cabinet bottom filled with leakage groove design, can ensure that the leakage will not leak to the outside.

Double locker to help achieve double lock management; The inner layer of the cabinet can be cancelled according to the actual use situation to enhance the utilization rate; The door is normally opened to the right (the left door can be customized according to the need), and the cabinet is designed with ventilation holes, and the cover can be opened for ventilation when necessary.

The top can be used as a workbench; There is a certain storage function inside the door plate, can place small reagent bottles or other items.

Storage cabinet with splicing function, can be left and right splicing to a 24 gallon size cabinet, the same, can be up and down splicing to a 24 gallon size cabinet, can also use

simple operation.

However

prevent the cabinet from dumping.

causing internal chemical leakage



ACP820012



### Polyethylene Corrosive Cabinets

Volume (Gal/L)	Doors Style	Ext dimension (H×W×D/cm)	Packing dimension (H×W×D/cm)	Adjustable Shelves (Pcs)	Volume of Bottom Leakage(Gal/L)	Model
12/45	One/Undercounter	89×53×55	91×55×57	2	3.5/13	ACP820012

\*Friendly reminder: When the chemicals in the strong corrosive chemical storage cabinet leak, the leaked chemical liquid will be concentrated in the leakage tank at the bottom of the cabinet. Please use absorbent cotton and other leakage prevention supplies to remove it in time under the guidance of professionals.

[1] Please refer to the Chinese national standard "List of Dangerous Goods GB 12268-2012" and the State Administration of Work Safety (SAWS) "Catalogue of Hazardous Chemicals"

## Corrosive Substance Storage Cabinet

1. Constructed of 8mm polypropylene (PP) panels, offering superior protection against harsh acid, alkali and corrosion.
2. Adjustable and reversible shelves meet diverse choices of users.
3. Formed with bent plates to make it stable and prevent from being out of shape.
4. Poly hinges and embedded door handles means there are no metal parts to corrode.
5. Divided into two parts to store different chemicals, making good use of storage space (48 Gal only).
6. Provided with independent vents which can be connected with exhaust systems.
7. Fully welded, liquid-tight 150mm sump contains accidental spills and has a regulations.
8. Door hasp accepts padlock to achieve double locks for security against unauthorized use.
9. Equipped with adjustable steel leg levelers on all four corners to keep the cabinet level.



### Corrosive Substance Storage Cabinet

Volume (Gal)	Certification	Door type	Material	Color	Ext dimension (H×W×D/cm)	Packing dimension (H×W×D/cm)	Adjustable Shelves	Adjustable Shelves (Pcs)	Model	Adjustable Shelf
4	CE	Singal	8mm PP (Polypropylene)	white	59x46x43	62x48x48	30	1	<b>ACP810004</b>	ACPL004
12	CE	Singal			89x59x46	91.5x61x49	30	1	<b>ACP810012</b>	ACPL012
12	CE	Singal (Double GA lock)			89x59x46	91.5x61x49	30	1	<b>ACP810012GA</b>	ACPL012
22	CE	Singal			165x59x46	179x66x53	30	2	<b>ACP810022</b>	ACPL012
24	CE	Double			89x90.5x58	102x92x57	50	1	<b>ACP810024</b>	ACPL024
25	CE	Four			180x59x46	193x66x53	30	-	<b>ACP810025</b>	-
30	CE	Double			112x109x46	125x116x52.5	50	1	<b>ACP810030</b>	ACPL048
40	CE	Eight			180x90x46	193x97x53	30	-	<b>ACP810040</b>	-
48	CE	Four			180x109x46	193x116x53	50	2	<b>ACP810048</b>	ACPL048
48	CE	Four			180x109x46	193x116x53	50	2	<b>ACP810048T</b>	ACPL048

## Oily Waste Cans

please use OSHA standard oily waste can. SYSBEL oily waste can has special lid whose opening angle is no more than 60 degree. The self-closing lid design ensures the can tightly closed in the absence of external force, to ef



Oily Waste Can Dolly

### Oily Waste Cans

Capacity (Gal/L)	Ext. Dimensions (H×D/cm)	Packing Dimensions (H×W×D/cm)	Steel Dolly for Oily Waste Cans		Red Model	Yellow Model
			Dolly Model	Ext. Dimension (D×H cm)		
6/22.6	40x30	42x46x38	WAS0014	43x8	<b>WA8109100</b>	<b>WA8109100Y</b>
10/38	46x35	47x52x44			<b>WA8109300</b>	<b>WA8109300Y</b>
14/53	51x41	53x57x49	WAS0021	49x8	<b>WA8109500</b>	<b>WA8109500Y</b>
21/80	60x47	62x61x54			<b>WA8109700</b>	<b>WA8109700Y</b>

\* Please refer to P51 for the matching special waste disposal bag

## Biohazard Waste Cans

- Constructed of polyethylene (PE), which are resistant to most chemical compounds.
- One-piece, blow-molded construction has no seams to develop leaks.
- Self-closing lid stays closed when not in use.
- Convex lugs moves easily from workstation to workstation.
- Foot lever opens lid to 60 degrees(max.) for hands-free access.
- Comply with OSHA 29 CFR 1910.125 and UL.
- Used to store most hazardous solid waste.
- With or without hazmat bags is permitted.
- Some of the chemicals that are not compatible with polyethylene are strictly forbidden, please refer to their Material Safety Data Sheet (MSDS).
- Grasp the lugs with both hands and keep level for carrying.
- Recommended to choose SYSBEL oily waste can for combustible waste storage.
- Loading on lid is prohibited.



### Biohazard Waste Cans

Material	Capacity (Gal/L)	Certification	Diameter(cm)	Packing Dimension (H*W*D/cm)	Red Model	Yellow Model
PE	6/22.7	CE	φ30	42x38x38	<b>WA8109200</b>	<b>WA8109200Y</b>
PE	14/53	CE	φ40	50x53x48	<b>WA8109600</b>	<b>WA8109600Y</b>

\* Please refer to P39 for the matching special waste disposal bag

## Safety Cans

The handle and clamp design, one force can open the can, which is easy to dump and carry. All models of security cans are equipped with a safety lock. The safety cans automatically close to prevent over flow and leakage effectively. The automatic pressure relieving system can relieve pressure when the pressure is within 0.2 to 0.35 kg / sq cm (3 to 5 pounds / square inch) to avoid accidental eruptions or explosion hazards.



Comply with OSHA29  
CFR910.106&1910.144 of OSHA as well as  
NFPA CODE 30 of NFPA



### Safety Cans

Capacity (Gal/L)	Certification	Ext. Dimensions (HxD/cm)	Packing Dimensions (H*W*D/cm)	Red Model TYPE I	Yellow Model TYPE I	Red Model TYPE II	Yellow Model TYPE II
2.5/9.5	CE	26x29	29x32x32	<b>SCAN001R</b>	<b>SCAN001Y</b>	<b>SCAN003R</b>	<b>SCAN003Y</b>
5/19	CE	40x29	43x32x32	<b>SCAN002R</b>	<b>SCAN002Y</b>	<b>SCAN004R</b>	<b>SCAN004Y</b>

## Plunger Can

Cans are made of High quality stainless steel, suitable for most cleaning chemicals. In the process of use, the liquid can be pumped from the can to the top tray by pressing the tray, which is convenient and quick to avoid waste. The special structure design can effectively control the liquid volatilization in the can into the air, reduce air pollution, maintain the physical and mental health of employees, and prevent the danger of gas explosion poisoning. By using plunger cans can effectively . At the same time, the



### Plunger Can

Dimension (diameter x height/cm)	Capacity (L)	Inner Packing Dimension (D×W×H/cm)	Outer Packing Dimension (D×W×H/cm)	Model
φ18*25	2	21×21×24.5	65×42×51 (12/Box)	<b>SCAN030W</b>
φ14*25	1.5	16×16×26.5	50×50×54 (18/Box)	<b>SCAN031W</b>





## Cigarette Butts Receptacle

Long poly tube design restricts oxygen and extinguish burning butts rapidly. Umbrella-shaped covered head keeps water out eliminates heat. Stainless steel connectors which tightly connect the receptacle have rust and corrosion resistance. Included steel pail that collects thousands of unsightly butt. Anti-theft design prevents theft or vandalism padlock is not provided.



CBR8102



CBR8101

### Cigarette Butts Receptacle

Capacity (Gal/L)	Ext. Dimensions (H×W×D/cm)	Packing Dimensions (H×W×D/cm)	Red Model	Gray Model
2/8	89.5x34.5x34.5	91x35.5x35.5	<b>CBR8101</b>	<b>CBR8102</b>

## VOC Filter Device

- VOC, which is harmful, will be generated when using safety cabinets. VOC is the abbreviation of volatile organic compound. Effectively reduce VOC concentration inside the cabinet.
- 
- Effectively absorb
- on any position in the cabinet.
- 
- The date on the label can remind user to replace the activated carbon bag; the life cycle of the activated carbon bag varies depending on the type and concentration of VOC.



Put the activated carbon bag into the cover



There are four magnets on the bottom of the position in the cabinet

### VOC Filter Device

Colour	External dimension (Length X Width X Height/mm)	Package size (Length X Width X Height/mm)	Quantity	Model
Silver white	225x65x70 Diameter 55	255x140x95	2	<b>WAB002</b>

Note: The model of the replaceable activated carbon bag is WAB002-1.

## Waste Liquid Collecting Barrel

Waste liquid generated from the process of laboratory experiment or manufacturing process can be harmful to the environment or human body if it is not collected and treated properly. Therefore, the collecting barrels are required to collect the liquid waste for the centralized treatment so as not to do harm to the environment or human body. SYSBE waste barrel can solve the problem of waste liquid collection.



### Waste Liquid Collecting Barrel

Product Name	Material	Capacity ( L )	External dimension (Height X Width X Length)(cm)	Colour	Model
Waste Liquid Collecting Barrel	HDPE	5L	25.5x16x18	White	<b>WAW005</b>
		10L	30.5x19x21.5		<b>WAW010</b>
		20L	40x26.5x29.5		<b>WAW020</b>
		30L	43x32x29		<b>WAW030</b>

## Safety Cabinet Parts

1



Cabinet Shelf  
WAL Series



2

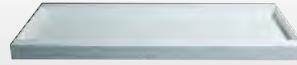

PP Shelf  
ACP Series



3



WAT045030  
Multipurpose Plastic Tray



4



PE Tray  
ACP Series



5



Step Laminate

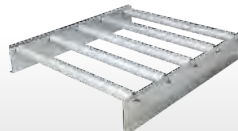

Safety Cabinet  
Roller  
WADR001

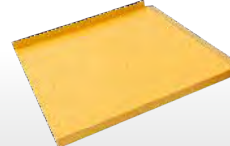

Safety Cabinet  
Ramp  
WAR001

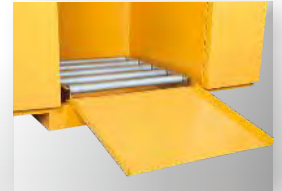

Anti-Static Device  
WA001/WA002

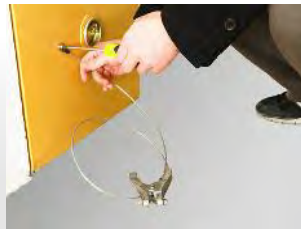

MSDS Document Box  
WAB001



Polyethylene locks



Oily Waste Can Dolly  
WAS Series



Type	Name of part	For the type of Cabinet	Ext. Dimensions (H×W×D/cm)	Model	Functions	
Shelf	1 Galvanized Steel Shelf	4 Gal	2.7x34x33	WAL040	needs	
		10 Gal	2.7x50x50	WAL010		
		12/15 Gal	2.7x50x36	WAL012		
		19 Gal	2.7x67x45	WAL019		
		22 Gal	2.7x51x36	WAL022		
		23 Gal	2.94x80x47	WAL023		
		30/45 Gal	2.7x100x36	WAL03045		
		54 Gal	2.7x51x77	WAL054		
		60 Gal	2.7x77x76	WAL060		
		90 Gal	2.7x100x76	WAL090		
	110 Gal	2.7x141x36	WAL110			
	2 PE Shelf	Corrosive Substance Storage Cabinets	3x38.8x30		ACPL001	Dif needs.
			3x48x43		ACPL002	
6x43.3x35.8				ACPL004		
6x56.3x38.8				ACPL012		
6x87.8x47.8				ACPL024		
6x106.5x38.7				ACPL048		
Explosion-proof cabinet	30/45Gal	5x98.9x31.5		ACPL030	Add storage partitions to meet personalized storage needs	

Name of part	Color	Leakage volume (Gal/L)	Ext. Dimensions (H×W×D/cm)	Model
3 Multipurpose Plastic Tray	Yellow	1.5/5.6	49x35x5.6	WAT045030
	Blue	1.5/5.6	49x35x5.6	WAT045030B

product specification	wall thickness	material	color	shape dimension (H×W×D/cm)	model	description
4 gallons cabinet PE plastic tray	2.2mm	PE	Milky white	34x33x2.2	WAT004	Place in cabinet to contain weak corrosive chemicals
12/22 gallons cabinet PE plastic tray	2.2mm	PE	Milky white	50x36x2.2	WAT01222	
30/45/90gallons cabinet PE plastic tray	2.2mm	PE	Milky white	100x36x2.2	WAT03045	
60 gallons cabinet PE plastic tray	2.2mm	PE	Milky white	76.4x76x2.2	WAT060	

Standard configuration	For weak corrosive liquid flameproof (blue metallic) cabinet only as standard
Optional configuration	Optional for other cabinets

Name of part	Ext. Dimensions (H×W×D/cm)	Model	description
5 Step Laminate (excluding stents)	15x55x37	ACPLS012	For 12 gallon/22 gallon PP cabinet ACP810012/ACP0022
	15x87x47	ACPLS024	For 24 Gallon PP Cabinet ACP810024
	15x106x37	ACPLS048	For 30 gallon/48 gallon PP cabinet ACP810030/ACP810048/ACP810048T
	15x77x37	ACPLS080	
	15x98x30	ACPLS045	For explosive metal cabinets WA810305B/WA810455B/WA810453B

Type	Name of part	For the type of Cabinet	Ext. Dimensions (H×W×D/cm)	Model	Functions
Cabinet Roller	Oily Drum Safety Cabinets Roller	55/110/115 Gal	11.5x75x68	WADR001	Supporting storage for oily and chemical drums
Cabinet Ramp	Oily Drum Safety Cabinets Ramp	55/110/115 Gal	11.5x68x58	WAR001	Special tread design to increase friction, convenient for oily drum cart loading and unloading operations
Ground Connection	Antistatic Device	Steel Safety Cabinets	Φ2mm, Length 1.5m	WA001	Promptly eliminate electrostatic charges, to prevent static sparks
	Antistatic Device	Steel Safety Cabinets	Φ2mm, Length 2m	WA002	
Document Box	MSDS Document Box	Steel Safety Cabinets	30.8x23x4.5	WAB001	Important documents data storage
Locks	Metal Locks	Metal Safety Cabinets	The lock rod DI 4mm	SCL001	Apply to double lock management
	Polyethylene locks	PP Safety Cabinets, Short	Inner Chain height 38mm	SCL002	
	Polyethylene locks	PP Safety Cabinets, Long	Inner Chain height 76mm	SCL003	
Ventilation Parts	Cabinet Ventilation Parts	Metal Safety Cabinets	"2"external thread, DN50	WA005	For external ventilation
	PP Cabinet Ventilation Parts	PP Safety Cabinets	"1.5"external thread, DN50	WA006	
			1.5x15x15	WA009	
			5x12x12	WA012	top air duct
Can Dolly	Oily Waste Can Dolly	14G Oily Waste Cans	8x43x43	WAS0014	Supporting and moving Oily Waste Cans easily
	Oily Waste Can Dolly	21G Oily Waste Cans	8x49x49	WAS0021	



## Spill Prevention, Containment & Control

Spill and leakage risks are major sources of hidden danger in the workplace. SYSBEL Spill Prevention, Containment & Control series, help you to keep the storage environment of oily and chemical drums clean, to effectively prevent and control possible liquid splashes, spills or pollution of spilled liquids. We also provide more emergency treatment products, to solve problems in a timely manner and cope with accidents with ease.



### 1. Determination of leakage source and risk judgment

Find the source of leakage and judge the hazard of the material at the leakage site: According to the chemical label and corresponding MSDS of the leakage treatment material, (explosiveness, reactivity and toxicity, etc.).

### 2. Deploy Personal Protective Equipment (PPE)

Necessary personal protective equipment (including protective clothing, respirators, gloves, glasses, chemical-resistant boots, etc.) should be worn at the spill disposal site. If the source leakage material cannot be determined, the possibility of the most serious consequences shall be considered, and PPE equipment that can respond to serious hazards shall be equipped to deal with the leakage safely.

### 3. Stop and control leaks

Control the development of leakage, close or limit the valve, or take appropriate measures to stop leakage. In the event of a container leak, care should be taken to keep the container upright.

### 4. Spill handling

Evaluate the magnitude of the leakage, and after the scope of the leakage is controlled, use the appropriate SYSBEL leakage emergency kit to deal with it in time. The absorbent pads in the set can deal with a small amount of leakage; the absorbent sock can contain the leakage, and the absorbent sock and absorbent pillow can be used for a large amount of leakage. After absorbing the leaked liquid, the absorbent cotton pollutants or harmful items should be properly transferred to chemical-proof disposal bags or packaged in SYSBEL leak emergency disposal barrels, and transferred to professional waste disposal agencies for disposal according to local regulations.

### 5. Decontamination

Complete the cleaning of personal protective equipment to prevent secondary pollution, keep the pollutants properly, and hand them over to a professional third-party agency for safe disposal.

### 6. Spill Disposal Report and Kit Supplement

Complete the leakage incident handling report and report to the superior management department. As soon as possible, make supplementary purchases for the easy-to-wear emergency treatment kits to deal with the next emergency leakage event.

## Poly Spill Decks

The poly spill deck is lower than the pallet, thus saving the space, improving the safety and chemical drums. Generally, the poly spill deck is used for storing oil drums, chemical drums, etc., instead of transferring such containers. When installed in a workshop, the spill deck can be used for various

also equipped with the same grate and drain holes. Various decks can be assembled to form a stable and reliable workstation.



Poly Spill Decks						
Type	200L Drum Quantity	Capacity (Gal/L)	Loading Capacity (Kgs.)	Ext. Dimensions (HxLxW/cm)	Forklift Operation	Model
Single Drum	1	11/42	600	15x68x68	NA	SPP401
4 Drum	4	26/100	2500	16x131x131	Bidirectional operation	SPP103-2

## Splicing Type Poly Spill Decks

The spliced polyethylene leakage platform is made of high-density polyethylene injection molding, which is sturdy and reliable. It can prevent the leakage of most chemicals, including strong corrosive substances such as acid and alkali. It is suitable for storing oil drums, chemical drums and other containers. , reduce the risk of water and soil contamination caused by leakage.

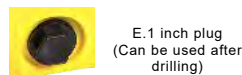
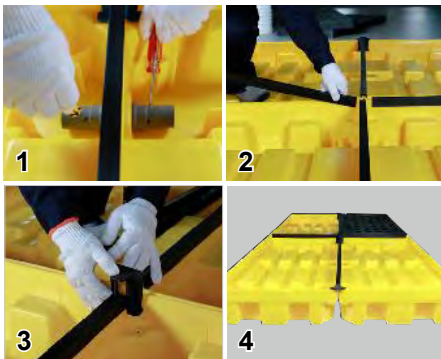
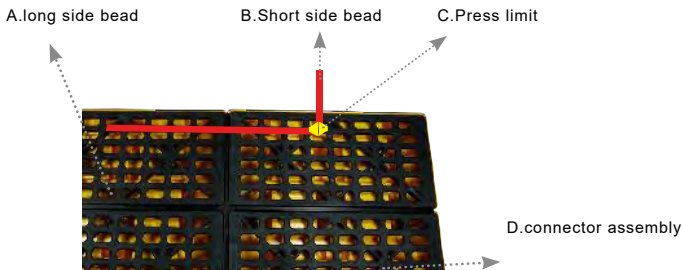

Accessories	No.	Name	Qty	Model
Single row short side splicing accessory bag	B	Short side bead	1	SPP014
	C	Press limit	2	
	D	connector assembly	1	
	E	Connecting hole 1 inch plug	2	
		8# Ziplock bag	2	
Single row long side splicing accessories package	B	long side bead	1	SPP015
	C	Press limit	2	
	D	connector assembly	2	
	E	Connecting hole 1 inch plug	4	
		8# Ziplock bag	2	
Double Row Long Side Expansion Kit	A	long side bead	2	SPP016
	B	Short side bead	1	
	C	Press limit	4	
	D	connector assembly	3	
	E	Connecting hole 1 inch plug	6	
Double Row Short Side Expansion Kit	A	long side bead	1	SPP017
	B	Short side bead	2	
	C	Press limit	4	
	D	connector assembly	3	
	E	Connecting hole 1 inch plug	6	
Multi-row and multi-column expansion kit	A	long side bead	1	SPP018
	B	Short side bead	1	
	C	Press limit	2	
	D	connector assembly	2	
	E	Connecting hole 1 inch plug	4	
	8# Ziplock bag	2		

## Splicing Type Poly Spill Decks

Name	Capacity (Gal/L)	Typ	Material	Color	Load Bearing Capacity (kgs)	Overall Dimensions (LxWxH/cm)	Package Size (LxWxH/cm)	Configuration	Model
Modular PE Spill Decks	23/90	1	PE	Yellow/black	1500	128x64x20	128x64x20	Grating*1 Pallet*1	SPP101-2

## Poly Spill Pallets

- The leaking tray has its own leaking tank, which can store, transport, and recycle oil drums and chemical drums. When leakage occurs, the liquid into the leaking tank without causing large-scale pollution.
- High-strength, movable and detachable grille is easy to disassemble, clean and replace.
- The drain hole can drain the liquid in the drain tank, which is convenient for most of the liquid to be recycled.
- The stacking limit is set around the pallet, which is convenient for stacking and transporting multiple pallets, saving space and transportation costs.
- Optional special slope, convenient and easy to carry.



SPP102



SPP102H



SPP104-2

\* Longitudinal edge set 550mm-650mm forklift slot

### Poly Spill Pallets

Type	200L Drum Quantity	Capacity (Gal/L)	Loading Capacity (Kgs.)	Ext. Dimensions (H×L×W/cm)	Forklift Operation	Model
2 Drum	2	32/120	1500	30×130×66	Bidirectional operation	<b>SPP102</b>
2 Drum	2	58/220	2000	45×131×67	Bidirectional operation	<b>SPP102H</b>
4 Drum	4	70/265	3000	30×132×131	Quadridirectional operation	<b>SPP104-2</b>

## IBC Poly Spill Pallet

The IBC leaking tray is made of 100% polyethylene material, and has a seamless structure, which is safe and reliable. It has a large capacity of 298 gallons (1130 liters), and has the characteristics of acid and alkali resistance, corrosion resistance and weather resistance, which can effectively prevent chemical hazards caused by liquid leakage are suitable for the sub-packaging and storage and transportation of medium-sized containers.

- The tray is sturdy and durable, and the reinforced curling design around it has higher strength and can play the role of anti-collision and anti-breakage;
- Anti-skid leakage grille, removable and detachable, easy to clean and transport;
- There are supports in the middle of the tray and the bottom of the grille, which are safer and more reliable to use;
- The design of stacked sleeves reduces storage space and transportation costs;
- There is a forklift slot at the bottom, which can be transported by forklift and hydraulic truck from 4 directions, making the transport easy and fast;
- Comply with EPA 40 CFR 264.175 standard and NPDES regulations.



SPP105

### IBC Poly Spill Pallet

Number of IBC Drum	Capacity (Gal/L)	Loading Capacity (Kgs.)	Ext. Dimensions (H×L×W/cm)	Forklift Operation	Standard	Model
1	298/1130	1600	90×135×135	Quadridirectional operation	EPA 40 CFR 264.175	<b>SPP105</b>

## Steel Spill Pallets

The steel leakage tray is made of 3mm hot-rolled steel plate, with a stable and durable structure, the main body of the tray is treated with epoxy resin powder coating, the surface is bright, dust-proof, rust-proof and moisture-proof, mainly used for storage, transfer, sub-packaging of oil drums and chemical Product barrel.

- The grille used with it has high strength, wear resistance, anti-aging, and can be dismantled and washed;
- It is suitable for the handling of various forklifts, and there are two-barrel pallets with the cart version, which makes the operation more convenient;
- The cylindrical bracket placed in the center of the pallet disperses the load, and the performance is more stable;
- Standard 3/4"NPT  
Liquid transfer, easy to operate;
- The plug at the bottom can completely release the leaking liquid and clean the tray.



Steel Spill Pallets						
Type	200L Drum Quantity	Capacity (Gal/L)	LoadingCapacity (Kgs.)	Ext.Dimensions (H×L×W/cm)	Forklift Operation	Model
2 Drum	2	48/180	2000	36×125×70	Bidirectional operation	SPM202
3 Drum	3	92/360	2700	33×200.5×82	Bidirectional operation	SPM304
4 Drum	4	92/350	3500	36×136×130	Quadridirectional operation	SPM204
2 Drum movable	2	48/180	1500	102×135×70	NA	SPM222

IBC steel spill pallet						
Name	Number of IBC Drum	Capacity (Gal/L)	LoadingCapacity (Kgs.)	Ext.Dimensions (H×L×W/cm)	Forklift Operation	Model
IBC steel spill pallet	1	317/1200	3500	79×136×130	Quadridirectional operation	SPM112

## Lab Spill Containment Pallets

The multi-functional laboratory tray is made of polyethylene material with excellent corrosion resistance and is integrally injection-molded. It has passed the 100% leakage test. The tray material is translucent, which is easy to observe the liquid level and leakage status.

- It can be placed on the laboratory table as an operating platform to prevent chemicals from contaminating the laboratory table during operation;
- It can be placed in a standard safety cabinet as a secondary container for corrosive chemicals, and can be placed and transported in batches;
- It can be placed inside the cabinet under the table, which can increase the total amount of leakage and protect the bottom of the test bench;
- The round holes set on the grid plate can temporarily place test tubes, which can be used as test tube racks to prevent damage to glass equipment caused by misoperation;
- Either side can be spliced to form a combined platform, expand the application area and the total amount of leakage, and protect the table;
- After removing the grid plate, the tray can be directly used for batch transfer of test samples.



Lab Spill Containment Pallets						
Name	Feature	LoadingCapacity (Kgs.)	Ext.Dimensions (H×W×D/cm)	Packing Size (H×W×D/cm)	Capacity (Gal/L)	Model
Lab Spill Containment Pallets	Leak-proof and corrosion-resistant laboratory Operating platform	15	49x36x10	50x37x11	3.5/13	SPL001

## Spill Control Accessories



SPP001



SPP012



SPP013

### Spill Control Accessories

Product	Types for pallet	Product Use	Loading Capacity (Kgs.)	Ext. Dimensions (H×L×W/cm)	Model
Poly Spill Pallet Ramp	SPP102 SPP104	The ramp serves for spill pallet makes the handling of bulk items easy.	454	30x120x80	<b>SPP001</b>
Poly Spill Deck Ramp	SPP103	It is dedicated to the spill deck. The supporting metal hook firmly connected the ramp with the deck. The ramp serves as an easy access to the transfer of drums and containers.	454	15x120x80	<b>SPP012</b>
Two-drum Poly Spill Deck Cart	SPP101 SPP101-2	It is dedicated to the spill deck. The supporting metal hook firmly connected the ramp with the deck. The ramp serves as an easy access to the transfer of drums and containers.	1500	102x131x63	<b>SPP013</b>

## Waterproof Tape

1. Easy to use, fast, very suitable for emergency.
2. Be made of thick waterproof butyl rubber, has strong viscosity and can widely suitable for many kinds of emergent situations .
- 3.



### Waterproof Tape

Unfold Size (Length Width/mm)	Roll-up Size ( Diameter Height/mm)	Material	Model
100x5000	115x100	butyl rubber	<b>SPP021</b>



## Absorbents

SYSBEL Absorbent(pad, sock and pillow)with melt blown polypropylene (MBPP) features high absorption rate, rapid absorption, good cleaning effect, which don't react with polar, toxic, hazardous chemicals, and is safe to use, causing no harm to personal health. Waste disposal is low in cost, and clean-up of spilled liquid is simple.It is a good helper for your workplace cleaning



OP0001W / OP0002W



CP0001Y / CP0002Y



UP0001G / UP0002G



OP0001WE



OP0003W



UP0003G



CP0003Y

anti-static

extractable

### Absorbent Pad

Type	Product	Size (cm)	Packing H*W*D/cm	Qty Per Carton	Absorbency Per (Gal/L)	Model	Features and Applications	
Absorbent Pad (easy to tear. light)	Oil-Only Absorbent Pad	50x40	23x52x42	100 pads	16/60	OP0001W	Easy-tear pressure point cotton pad, the surface is ultrasonic pressure point, stronger	
	Hazmat Absorbent Pad					CP0001Y		
	Universal Absorbent Pad					UP0001G		
Anti-static Absorbent Pad	Anti-static Oil-Only Absorbent Pad	50x40	23x52x42	100 pads	16/60	OP0001WE		
Absorbent Pad (Easy tear type. heavy)	Oil-Only Absorbent Pad	50x40	42x52x42	100 pads	32/120	OP0002W		
	Hazmat Absorbent Pad					CP0002Y		
	Universal Absorbent Pad					UP0002G		
Absorbent Pad (extractable. light)	Oil-Only Absorbent Pad	40x33	42x35x30	150 pads	16/60	OP0003W		Eight-layer composite, tear-open carton, easy to extract and use, easy to manage the production line of the workshop, and more tidy
	Hazmat Absorbent Pad					CP0003Y		
	Universal Absorbent Pad					UP0003G		



OM0001W



CM0001Y

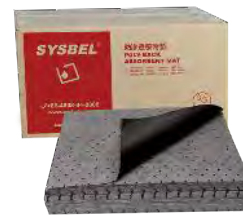

UM0001G

### Impermeable Adsorbent Pad

Type	Product	Size (cm)	Packing H*W*D/cm	Qty Per Carton	Absorbency Per (Gal/L)	Model	Features and Applications
Impermeable Adsorbent Pad (not sticky)	Oil-Only Impermeable Adsorbent Pad	50x40	30x52x47	100 pads	24/90	OM0001W	After absorbing oil or liquid, oil squeeze or liquid will not penetrate into the ground to avoid secondary pollution. It is suitable for production workshops, chemical plants, laboratories, etc. that need clean ground
	Hazmat Impermeable Adsorbent Pad					CM0001Y	
	Universal Impermeable Adsorbent Pad					UM0001G	



OS0001W



CS0001Y



US0001G



Absorbent Sock							
Type	Product	Size (cm)	Packing H*W*D/cm	Qty Per Carton	Absorbency Per (Gal/L)	Model	Features and Applications
Absorbent Sock	Oil-Only Absorbent Sock	7.6x120	30x55x42	12 socks	15/57	OS0001W	It is soft and can be bent arbitrarily and placed in the required place to prevent the spread of chemicals and other harmful liquids. It is suitable for vehicles with harmful liquids, chemical plants, laboratories and other places where the leakage of harmful liquids may be possible.
	Hazmat Absorbent Sock					CS0001Y	
	Universal Absorbent Sock					US0001G	



SOR001 / SOR002



SCR001 / SCR002



SUR001 / SUR002

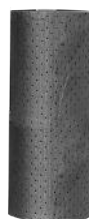

SUR003

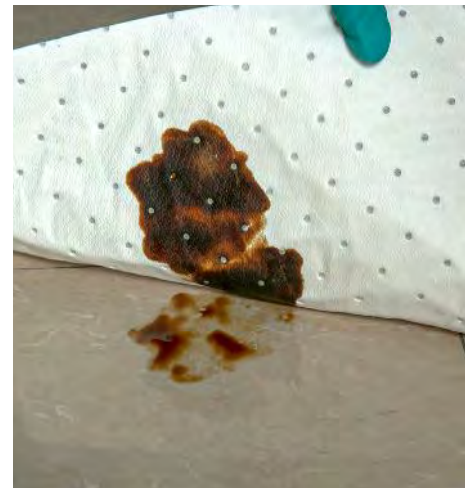

Absorbent Roll							
Type	Product	Size (cm)	Packing H*W*D/cm	Qty Per Carton	Absorbency Per (Gal/L)	Model	Features and Applications
Absorbent Roll (easy to tear. light)	Oil-Only Absorbent Roll	40x5000	42x38x38	1 roll	16/60	SOR001	Easy-tear pressure point cotton roll, the surface is ultrasonic pressure point, stronger
	Hazmat Absorbent Roll					SCR001	
	Universal Absorbent Roll					SUR001	
Absorbent Roll (Easy tear type. heavy)	Oil-Only Absorbent Roll	40x5000	42x55x55	1 roll	32/120	SOR002	
	Hazmat Absorbent Roll					SCR002	
	Universal Absorbent Roll					SUR002	
	Universal Absorbent Roll	91x5000	-	1 roll	72/272	SUR003	



SOP001



SCP001



SUP001



**Absorbent Pillow**

Type	Product	Size (cm)	Packing H*W*D/cm	Qty Per Carton	Absorbency Per (Gal/L)	Model	Features and Applications
Absorbent Pillow	Oil-Only Absorbent Pillow	45x45x5	50x45x45	10 pillows	20/75	SOP001	Small size, large adsorption capacity, suitable for the ground with chemical and oil leakage, under the faucet, valve, mechanical pipeline
	Hazmat Absorbent Pillow					SCP001	
	Universal Absorbent Pillow					SUP001	



OB0001W



CB0001Y



UB0001G

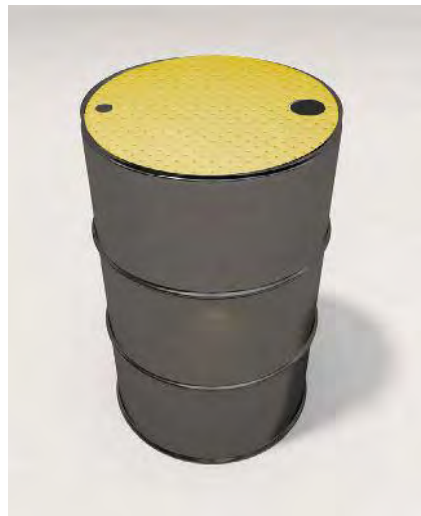

DOP001



DCP001



DUP001

**Absorbent Boom & Drum Mat**

Type	Product	Size (cm)	Packing H*W*D/cm	Qty Per Carton	Absorbency Per (Gal/L)	Model	Features and Applications
Absorbent Boom	Oil-Only Absorbent Boom	12.7x300	50x55x55	4 socks	24/90	OB0001W	It is soft and can be bent arbitrarily to prevent oil leakage and spread. It has reinforced mesh sleeves and metal hooks, which can be linked to each other. It is suitable for oil tankers, mailboxes, oil pipelines, workshop machines, water surfaces and other places with oil leakage.
	Hazmat Absorbent Boom					CB0001Y	
	Universal Absorbent Boom					UB0001G	
Drum Mat	Oil-Only Drum Mat	55 (DIAM)	14x56x56	25 pieces	7/27	DOP001	Fits the drum perfectly, leaving holes for easy installation and use of drum accessories, suitable for 210L (55gal) drum tops
	Hazmat Drum Mat					DCP001	
	Universal Drum Mat					DUP001	

## Heavy Durable Absorbent Mat

### High quality

The absorbent mats are made of polyester and with excellent features and unique crafts. The absorbents mats are stickup and level but not curly. It can avoid the hurt of slippery and stumble effectively.

### High strength and durable

The absorbent mats are so durable that they can stand heavy tool cars, forklifts driving repeatedly.

### Strong absorption capacity

With excellent absorption capacity and speed, the absorbent mats can absorb and lock the oil wastes, coolant and solvent like water quickly.

### Leakage-proof

The unique layer can prevent any liquid leakage, lock the liquid and avoid to cause secondary pollution and keep the ground dry and safe.

### Easy to use

The absorbent mat can be cut in any way and easy to change and lift, not easy to leave residual glue. It can fully protect the ground and reduce the cleaning time.



SUR006  
Without adhesive



SUR007  
back gum

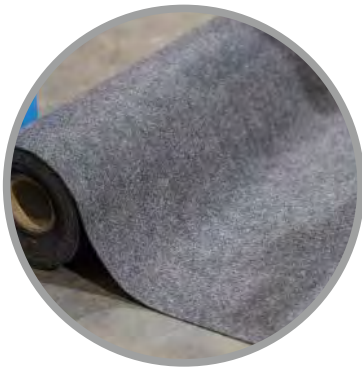

### Heavy Durable Absorbent Mat

Product Name	Color	Absorbency (L/roll)	Product Packaging	External dimension (LxW/cm)	Package dimension (DxH/cm)	Model
Heavy absorbent mat roll (Without adhesive)	Black	Absorption up to 50L	1 roll / bag	3000 x 90	φ30 x 92	<b>SUR006</b>
Heavy absorbent mat roll (back gum)	Black	Absorption up to 50L	1 roll/bag	3000 x 90	φ30 x 92	<b>SUR007</b>

## Chemical spill emergency treatment



### White

- Dedicated to the absorption of oil, instead of water



### Yellow

- Especially for absorbing acidic and corrosive liquids, or other unknown hazardous liquids (both oil and liquid)



### Gray

- Universal type, absorbing both oil and water



## Wipes

SYSBEL , etc., with high absorption rate, fast absorption, non-combustion, high cleaning, etc., do not react with polar, toxic and dangerous chemicals, safe to use, and good for human health No hazard, low waste disposal cost, easy and labor-saving cleaning of leaked liquids, it is a good helper for your workplace cleaning!



SWF101



### CLEANROOM WIPES

Name	Color	Product Packaging	Size (cm)	Type	Inside Box (L×W×H/cm)	Outside Box (L×W×H/cm)	Model	Features and Applications
CLEANROOM WIPES	White	280/Box 60 boxes/Carton	11x20	Removable	12.5x12x7.5	52.5x41x40	SWF101	Precision wiping of laboratory equipment, special parts, precision instruments, etc.: 1. Ultra-low dust; 2. The paper is delicate and will not scratch the surface to be wiped; 3. Prevent static electricity and dust from being generated; 4. Good dry and wet strength, not easy to break; 5. Efficient water absorption, pure texture, 100% virgin wood pulp; 6. Pass the ROHS test.



SWR201Y



SWF201Y



### WIPES

Name	Color	Product Packaging	Size (cm)	Type	Outside Box (L×W×H/cm)	Model	Features and Applications
WIPES	Yellow	420 pcs/roll 2 rolls/box	23x40	Roll	62x32x24.5	SWR201Y	Parts and tool cleaning, wiping and maintenance of mechanical equipment, cleaning of laboratory utensils and countertops, etc.: 1. Efficient water and oil absorption capacity, 100% virgin wood pulp; 2. Appropriate wiping strength, not easy to break; 3. It is not easy to leave hair dust after wiping; 4. The surface is embossed to increase the friction of the wiping contact surface; 5. FDA direct contact with food material certification.
	Yellow	60 pcs/pack 20 pack/box	27x30	Flat Sheet	56x31.5x31.5	SWF201Y	



SCR301B



SCB302B



### WIPING CLOTH

Name	Color	Product Packaging	Size (cm)	Type	Outside Box (L×W×H/cm)	Model	Features and Applications
WIPING CLOTH	Blue	500 pcs/roll 2 rolls/box	23x34	Roll	52x27x24.5	SCR301B	1. High absorption performance; 2. High dry and wet strength, can be used with solvents to meet daily wiping needs; 3. Very low chip removal and no dust left after wiping; 4. Does not fade; 5. Pass the ROHS test; 6. FDA
	Blue	200 pcs/box	30x42	Removable	33x24x20	SCB302B	



SCR321W



SCB321W



**Almighty Wiping Cloth**

Name	Color	Product Packaging	Size (cm)	Type	Outside Box (L×W×H/cm)	Model	Features and Applications
Almighty Wiping Cloth	white	900 pcs/roll 1 roll/box	30x34	Roll	41x41x33	SCR321W	1. High absorption performance; 2. High dry and wet strength, can be used with solvents to meet daily wiping needs; 3. Very low chip removal and no dust left after wiping; 4. Does not fade; 5. Pass the ROHS test; 6. FDA direct contact with food material certification.
	white	200 pcs/box	30x42	Removable	33x24x33	SCB321W	



SCB331B



**Strong Oil Absorbing Wiping Cloth**

Name	Color	Product Packaging	Size (cm)	Type	Outside Box (L×W×H/cm)	Model	Features and Applications
Strong Oil Absorbing Wiping Cloth	Blue	160 pcs/box	30x42	Removable	33x24x33	SCB331B	Application industry: Coatings, inks, chemical pigment production, screen printing, digital inkjet printing, biopharmaceuticals, petrochemicals, heavy equipment manufacturing, metal processing, etc. High-efficiency adsorption performance, can quickly absorb oil that is several times its own weight and wipe without leaving hair. Dust, reduce the risk of pollution, improve the yield rate, can be used in conjunction with solvents, strong solvent resistance, strong material has strong wet strength, wet wiping is more effective in decomposing oil stains, clean and efficient double row extraction, easy to tear, easy to carry

NEW



Material: Polypropylene PP  
 Features: Need not use water, strong decontamination

SCP101

NEW

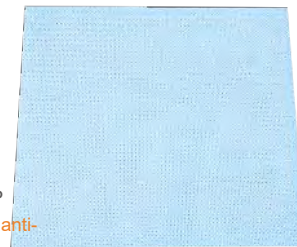

Material: Polypropylene PP  
 Features: Fast absorption, anti-leakage

SCC101



**Wet Scrubbing Wipers**

Color	Size (cm)	Product Packaging	Outside Box (L×W×H/cm)	Model
orange	27x30	100 pcs/barrel 2barrels/box	45x22.5x21	SCP101

**Table Protection Pad**

Color	Size (cm)	Product Packaging	Outside Box (L×W×H/cm)	Model
Blue	45x60	100 pcs/bag 2bags/box	51x47x7.5	SCC101

## Overpack Salvage Drum

This product is applicable to temporary storage and transportation of hazardous wastes (such as flammable, corrosive and toxic substances), and widely applied in secondary packaging, transportation, transfer and spill handling, etc. It is manufactured by one-time rotational molding and can realize 100% spill protection. It also has good toughness. Polyethylene is resistant to UV rays, corrosion and most chemicals. The emergency treatment drum can be nested to reduce the storage space and transportation costs.



SYD950

SYD200

## Steel Dolly for Overpack Salvage Drum

The 95Gal overpack salvage drum is slightly heavy in emergency treatment of chemical spill. In order to improve the mobility, the sliding rails can be used. Two operation.

Note: It is recommended to apply the rails only to the drum with spill kits.



SYD001

### Overpack Salvage Drum

Product	Certification	Capacity (Gal/L)	Loading Capacity (Kgs.)	Top Diameter(cm)		Bottom Diameter(cm)		Height(cm)		Ext.Dimensions (Height×Diameter/cm)	Model
				Outer	Inner	Outer	Inner	Outer	Inner		
Overpack Salvage Drum(95Gal)	CE	95/360	292.5	78.5	72.5	64.5	62.5	104	97	104x78.5	SYD950
Overpack Salvage Drum(20Gal)	CE	20/75.7	60	57	51	48	45	60.5	58	60.5x57	SYD200

### Steel Dolly for Overpack Salvage Drum

Product	Capacity (Gal/L)	Bottom Diameter(cm)		Height(cm)	Ext.Dimensions (Height×Diameter/cm)	Model
		Outer	Inner	Inner		
Steel Dolly for Overpack Salvage Drum	100	67	66.5	2	8x67	SYD001

## Overpack Spill Kit

With a variety of adsorption materials, help you respond quickly to unexpected incidents, and can isolate hazardous waste and contaminants with the spill barrel to prevent secondary leakage hazard, which is suitable for large-scale spill.



SYK2009(Universal)



SYK201(Chemical Only)



SYK202(Oil Only)





SYK950(Universal)



SYK951(Chemical Only)



SYK952(Oil Only)

### Overpack Spill Kits

Model	Capacity (Gal/L)	Absorbent Pad	Absorbent Sock	Absorbent Pillow	Hazamat Disposal Bags	cable Tie	Safety Goggles	Safety Gloves	Wipe
SYK200 SYK201 SYK202	20/75	25 pcs	6 pcs	5 pcs	1 pcs Medium	3 pcs	1 pair	1 pc	1 bag
SYK950 SYK951 SYK952	80/302	125 pcs	24 pcs	15 pcs	10 pcs Large	10 pcs	1 pair	1 pc	2 bag

### 65-Gallon Wheeled Poly-Overpack Salvage Drum & Overpack Spill Kit

SYSBEL 65-Gallon Wheeled Poly-Overpack Salvage Drums are special containers which are suitable for temporary storage and transport of hazardous waste. Widely used in secondary packaging, transportation, emergency spill treatment to eliminate hazardous materials and secondary leakage occurs. Built-in wheels eliminate the need for a separate dolly or other transport; Help to provide you with the most effective and low cost safety solutions.



SYD650



SYK650(Universal)



SYK651(Chemical Only)



SYK652(Oil Only)

### 65Gal-Drum Overpack Spill Kits

Spill Capacity (Gal/L):60/228

1 pc 65-gallon wheeled poly-overpack salvage Drum 125 pcs 50cm×40cm absorbent pad, 16 pcs 7.6cm×120cm absorbent sock, 10 pcs 45cm×45cm absorbent pillow, 2 bags (60 pcs/bag) Industrial Wipe ,10 pcs hazamat disposal bags, 10 pcs cable tie, 1 pair of Rax-9202 safety goggles, 1 pair of safety gloves, 1 pc user manual

### 65Gal-Wheeled Poly-Overpack Salvage Drum

Material	Capacity (Gal/L)	Ext. size(H×W×Dcm)	Handle to Floor Distance(cm)	Max.External Diameter(cm)	Opening Diameter	Loading (kgs)	Model
Polyethylene	65/246	117x71x78.5	96.5	71	62.5	300	<b>SYD650</b>

## Mobile Spill Kit

Mobile spill kits, with a variety of absorbents combination to help you respond quickly to unexpected incidents. Wheelie bin helps you to send SYSBEL professional adsorbent materials to every corner of the factory, to respond to spills accident or sewage treatments in the factory, which is suitable for medium-scale spill.



SKIT002G(Universal)



SKIT002Y(Chemical Only)



SKIT002W(Oil Only)

### Mobile Spill Kit

Spill Capacity(Gal/L):45/170

125 pcs 50cm×40cm absorbent pad, 12 pcs 7.6cm×120cm absorbent sock, 5 pcs 45cm×45cm absorbent pillow, 2 bags (60 pcs/bag) Industrial Wipe , 5 pcs hazamat disposal bags, 5 pcs rope, 1 pc safety spectacle, 1 pair of safety gloves, 1 pc user manual

## Spill Kits Refill

Rapid response to an emergency can be made by combining various absorbing materials, without purchasing new wheelie bins or salvage drums. The product can be directly used with the existing package to rapid



SKS001G(Universal)



SKS001Y(Chemical Only)



SKS001W(Oil Only)

### Spill Kits Refills

Spill Capacity (Gal/L):10/38

20 pcs 50cm×40cm absorbent pad, 2 pcs 7.6cm×120cm absorbent sock, 2 pcs 45cm×45cm absorbent pillow, 2 pcs big hazamat disposal bags, 2 pcs medium hazamat disposal bags, 4 pcs cable tie, 4 pair of safety gloves, 1 pc user manua

## Portable Spill Kit



SKIT001G(Universal)



SKIT001Y(Chemical Only)



SKIT001W(Oil Only)

### Portable Spill Kit

Spill Capacity (Gal/L):11.5/43.5

1 pc portable bag 25 pcs 50cm×40cm absorbent pad, 6 pcs 7.6cm×120cm absorbent sock, 1 pc hazamat disposal bags, 1 pc cable tie, 1 pc safety spectacle, 1 pair of safety gloves, 1 pc user manual

In production and construction sites, leakage is unavoidable, even if you are careful, there will be unexpected situations. Especially for some substances that are prone to leakage and pollution, we need to take adequate precautions and preparations in advance. If the leakage is not handled in a timely and professional manner, it will not only af

### Spill Kits in Cart



#### Spill Kits Cart

Material	Certification	Door Type	Color	Product Size (H*W*D/cm)	Packing Size (H*W*D/cm)	Model
High-quality galvanized steel	CE	Single	Yellow	113.5 x 65 x 55	129 x 79 x 63	<b>WA940640</b>

#### Spill Kits in Cart

Spill Capacity (Gal/L): 48~56 / 181~212

1 Trolley Manual of Accidental Release Measures, 100 pcs 50cm×40cm absorbent pad, 4 pcs 45cm×45cm absorbent pillow, 4 pcs 7.6cm×120cm absorbent sock, 5 pcs hazamat disposal bags and ropes, 1 pair of Ra×-9202 safety goggles, 1 pair of safety gloves, 1 Absorbent Roll, 1 pc user manual

### Polyethylene Spill Kits Cart



#### Polyethylene Spill Kits Cart

Material	Certification	Door Type	Color	Product Size (H*W*D/cm)	Height of handle from ground/cm	Model
Polyethylene Spill Kits Cart	CE	Single	Yellow	100 x 48 x 52	96.5	<b>SYK320Y</b>
Polyethylene Spill Kits Cart	CE	Single	Gray	100 x 48 x 52	96.5	<b>SYK320G</b>

#### Polyethylene Spill Kits Cart

Spill Capacity (Gal/L): 30/114

1 pc polyethylene cart, 1 roll absorbent roll, 4 pcs 7.6cm×120cm absorbent sock, 4 pcs 45cm×45cm absorbent pillow, 1 bag(60pcs) Industrial Wipe, 5 pcs hazamat disposal bags and cable tie, 1 pair of safety goggles, 1 pair of safety gloves, 1 pc warning sign, 1 pc user manual

## PVC Float-Type Spill Containment Boom

- Tough polyethylene bags resist punctures, tearing and blowouts
- Reliable bag hazardous or contaminated waste for disposal
- Durable 0.08mm thickness
- Ideal for lining drums or short-term storage of saturated absorbents and other waste products
- Bright yellow bags are signally labeled "CAUTION Hazardous Material - Handle With Care"



### PVC Float-Type Spill Containment Boom

Feeboard (mm)	Daft (mm)	Section Length (m)	Working Condition				Model
			Tention Strenght(kn)	Wave Height(m)	Wind Speed(m/s)	Flow Rate(kn)	
140	370	20	45	0.3	8	1	FTB001
270	380	20	60	0.5	10	1.5	FTB002
290	380	20	70	0.5	15	1.5	FTB003
310	470	20	100	1	20	2	FTB004
510	740	20	150	2	20	3	FTB005

## Polyethylene Disposal Bags

- Tough polyethylene bags resist punctures, tearing and blowouts
- Reliable bag hazardous or contaminated waste for disposal
- Durable 0.08mm thickness
- Ideal for lining drums or short-term storage of saturated absorbents and other waste products
- Bright yellow bags are signally labeled "CAUTION Hazardous Material - Handle With Care"



### Polyethylene Disposal Bags

Type	Description	one-sided / Dimensions	Description	Model
Small	55x60	6 mil	WA8109100, WA8109200, WA8109300	<b>SYB060. SYB060R. SYB060B</b>
Medium	70x80	6 mil	WA8109500, WA8109600, WA8109700	<b>SYB200. SYB200R. SYB200B</b>
Large	150x90	8 mil	-	<b>SYB950. SYB950R. SYB950B</b>

\* Color can be customized

## Universal Absorbent Drip Pan

Universal absorbent drip pan can be placed in most places where there is dripping, to protect the environment clean and safe.

Features:

1. The leaking box is equipped with adsorption material with high adsorption capacity, and each box can hold up to 3 liters of dripping liquid.
2. The leaking box is very stable after being placed, it is not easy to overturn, and it is safe to use.
- 3.

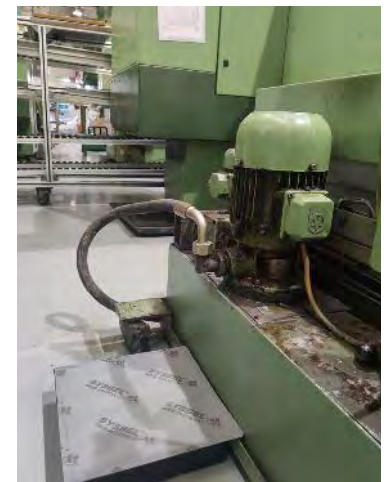

### Universal Absorbent Drip Pan

Color	External dimension (LxW/cm)	Package dimension (LxWxH/cm)	Absorbency (Gal/L/Box)	Model
Black	7×30×30	42×62×32	9.6/36	<b>DUP002</b>

## Portable Spill Containment Berm

It can be used for storing oil barrels, chemical barrels and other items in the factory, as well as for personnel cleaning and vehicle cleaning pools, etc. Adapt to the leakage prevention work in various environments. Products can be quickly opened and folded, expanded to use after folding. Compact easy to carry.



Portable Spill Containment Berm  
(with support)



Portable Spill Containment Berm  
(support-free type)

### Portable Spill Containment Berm

Type	External dimension (Height X Width X Length)(cm)	Capacity	Material	Colour	Model
with support	180x180x30	190Gal/720L	PVC/Stainless Steel	Yellow	SPPB001
with support	360x360x30	700Gal/2650L	PVC/Stainless Steel	Yellow	SPPB002
upport-free type	100x100x10	20Gal/75L	PVC	Orange	SPPB101
upport-free type	80x120x10	20Gal/75L	PVC	Orange	SPPB102

## Pool

The overall structure is smaller at the top and larger at the bottom, which can ensure that the overturning will not occur after water storage. There is a built-in soft tank edge at the top, which can not only ensure a certain strength and support, but also effectively prevent the of water. At the same time, the top cover can be to protect the contents of the pool from being polluted. Equipped with open valve couplings.



### Pool

Name	External dimension (Height x Diameter of upper mouth x Diameter of lower bottom)(cm)	Packing dimension (Length x Width x Height) (cm)	Capacity	Material	Colour	Model
Pool	80x98x154	30x40x20	1m <sup>3</sup>	PVC	Yellow	SPPP001
Pool	90x140x192	50x40x20	2m <sup>3</sup>	PVC	Yellow	SPPP002
Pool	116x198x278	50x40x40	3m <sup>3</sup>	PVC	Yellow	SPPP003

## Roof Leak Diverter

Roof diverter use for roof leakage collection in of ce, warehouse and other place, Prevent dripping from the surface of equipment, goods or the ground, reduce the loss caused by water leakage, ensure the safety of the environment, goods and personnel safety.

The product is a rectangle. There is a hose coupler at the middle bottom, which can be connected with a hose to drain the water to the designated place.

High in the middle and low in the surrounding area to ensure water ow to the concentrated area; The four corners are tied up and equipped with a rope buckle. Four S-shaped curved hooks are used to the ceiling.



### Portable Spill Cont

External dimension (Height X Width X Length)(cm)	Material	Colour	Model
80x80	PVC	White	SPPD001
120x120	PVC	White	SPPD002



## Special Protective Products

There are many dangers in the process of production, scientific research, teaching and other operations, which threaten the personal safety and health of the operators. Health provides better protection.



## Eye/Face Wash

SYSBEL's new nozzle heads colligate traditional aerators and spray heads with holes. Zero velocity point provides more comfort and control for effective sweeping hazardous contaminants away from the face and eyes using a soft aerated stream for eye wash and independently angled face wash stream for optimum coverage. This series of products fully complies with ANSI Z358.1-2014 and AS 4775-2007, and has been tested and approved by CSA.

- The unique nozzle design is adopted. The same height can be maintained under certain water pressure, to avoid the operating obstacles caused by water pressure.
- The nozzle can be used for spraying two kinds of water at the same time, with balanced heights.
- The aerator with a coin slot is easy to remove and install, and thus simple to clean and maintain.
- The dust-proof cover can protect the nozzle from being contaminated by dust in the air. Once the eyewash is started, the dust-proof cover will be
- The copper nut is built in the 304SS nozzle base and connected to the horn elbow, and its strength is enough to allow repeated removal and installation and ensure longer service life.
- The nozzle is made of AES engineering plastic which is superior to ABS engineering plastic, and has outstanding features of weather resistance, high rigidity, corrosion resistance, UV resistance, etc.
- applicable to adverse workplaces.

to the eyes. In addition, the connector is easy to operate, which is conducive for cleaning and maintenance on a regular basis.

- The eye/face wash series fully comply with ANSI Z358.1-2014 and AS 4775-2007, and has been tested and approved by CSA.



It complies with the regulations in ANSI Z358.1-2014 standard and OSHA 29 CFR 1910.151(C) issued by ANSI has acquired CE Certification



## Shower head

SYSBEL's safety showers provide conical water pattern and gently deliver large volumes of water to realize complete decontamination without injury to skin. It ensures the fastest, most effective removal of contaminants in emergency. The shower equipment complies with the standard of ANSI Z358.1-2014 and approved by CSA.

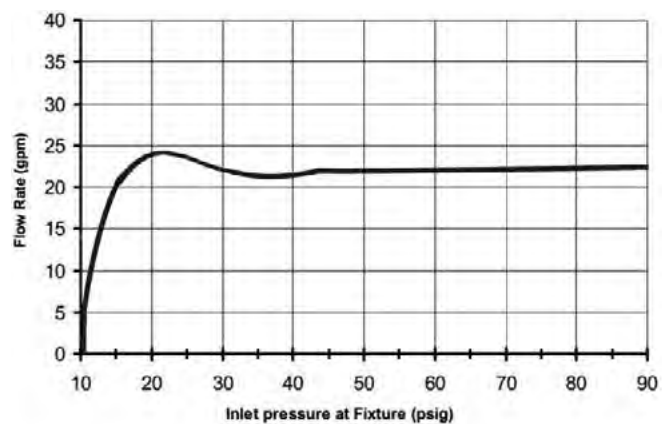
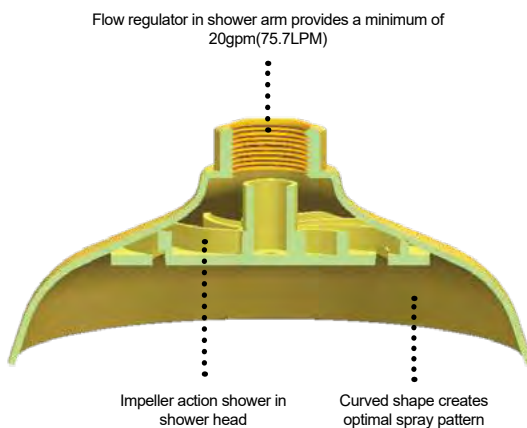

### NOTE:

Spinkler head features flow regulator (exceeds minimum water flow of 20 GPM (75.7LPM) at 30 PSI (2.0 bar)) in shower arm pipe, which not only delivering adequate and stable flushing fluid, but conserving water as well as helping users to decontaminate more effectively.



# QUICK COMPLIANCE GUIDE Combination Unit

- 1 Valve mechanism activates in one second or less; it stays open until manually closed. (Section 4.2, 5.2, 6.1.4, 6.2)
- 2 . (Section 4.5.5, 7.4.4)
- 3 . (Section 4.1.3, 4.5.4)
- 4 W for 15 minutes. (section 4.1.2, 4.5.5)
- 5 Valve actuator shall be located not more than 175.3cm (69") above . (section 4.2)
- 6 The diameter shall be minimum of 50.8cm (20") at 152.4cm (60") . (section 4.1.4)
- 7 ) from any obstruction. (Section 4.1.4, 4.5.4)
- 8 W 53" (134.6cm) from the level on which user stands and 6" (15.3cm) minimum from the wall or nearest obstruction. (Section 5.4.4, 6.4.4)
- 9 Deliver at least 3.0 gallons (11.4 liters) of water per minute for 15-minute (Section 6.1.6, 6.4.5)
- 10 Constructed of materials that will not corrode in the presence of the , 7.1.2, 7.1.3)
- 11 Located 10 seconds or 55 feet from contaminants or hazardous materials. Locate on the same level as hazard and free of obstructions. (Section 7.4.2, B5)
- 12 Protect nozzle head from airborne contamination, dust covers shall
- 13 velocity low enough without injury to skin (Section 5.1.1, 6.1.1)

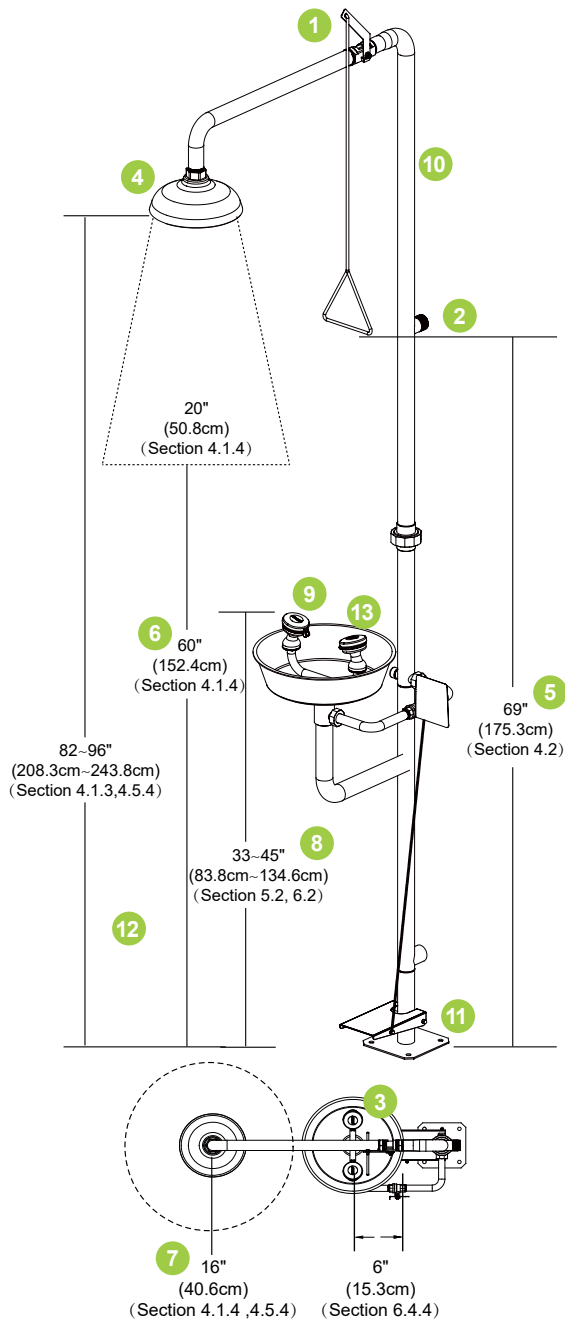

1. Water delivered by combination unit shall be tepid (60-100°F/16-38°C) (Section 4.5.6, 5.4.6, 6.4.6, B6)



2. 15-minute Flush Required combination unit shall provide at least 3.0gpm (11.4lpm) of water for 15 minutes (Section 7.4.5, B6)



with a highly visible sign, the area (Section 7.4.3)



4. Training Instruct all employees who maybe exposed to hazardous materials in the location and proper use of



5. Weekly activations & Annually inspections Activate combination unit at least weekly and inspect annually for compliance with requirements of ANSI-Z358.1 (Appendix B2)a



6. Recommend to connect a pressure of 210kPa (30psi) (Appendix B2)





## Combination Unit

- Application: Provide full-body relief from contamination fastly and effectively
- Materials: AES plastic + 304 Stainless Steel
- AES plastic has weather resistance properties and applies to indoors or outdoors
- With good acid-proof ,alkali prevention performances,304SS is ideal for harsh environment
- Pull rod with triangular handle is easy to operate for showers
- The design with equal length of main pipes makes packaging more compact so that helps to save space and cost
- 
- Flow regulator is built in shower arm tube
- 
- Activated by push handle or foot pedal easily
- The coin slot hidden faucet aerator is esay to remove and clean
- Dust cover is removed once unit started
- Comply with ANSI Z358.1-2014 and AS 4775-2007



WG7053F



WG7053FY



WG7053FG



WG7053P

## Mounting Bracket

- SYSBEL provides mounting brackets



## Combination Unit

Main Materia	Flow Rate L/min		Water Bowl		Shower		Valve	Inlet	Outlet	Pressure KPa	Packing size LxWxH (cm)	Certification	Model
	Eye/ Face Wash	Shower	DxH/cm	Materia	DxH/cm	Materia							
304 Stainless Steel	11.4	75.7	32×9.5	304SS	25.5×7.5	304SS	1/2"	1"	1"	210	120×40×26.5	ANSI Z358.1 AS 4775 CSA CE	<b>WG7053F</b>
			32×9.5	AES plastic	25.5×7.5	AES plastic							<b>WG7053FY</b>
			32×9.5	304SS	25.5×7.5	304SS							<b>WG7053FG</b>
ABS plastic			30.5×8	ABS plastic	25×7.5	ABS plastic		Rc1-1/4	Rc1-1/4		63×40.5×26	GB/T38144.1 GB/T38144.2	<b>WG7053P</b>

## Composite self-draining emergency eyewash shower

The self-draining eyewash is an eyewash that can automatically empty the water inside the eyewash. All the water in the eye washer can be emptied after use to ensure that there is no water in the eye washer and will not cause corrosion or freezing in the low temperature environment to ensure the safety and use of the eye washer.

The main material of the eyewash is made of 304 stainless steel, and the stainless steel has been pickled and passivated, and has stronger corrosion resistance to acid, alkali, salt, and oil chemicals. The eyewash hand push valve adopts a two-piece ball valve, which has a small operating force and is convenient for users to quickly open, which is more suitable for use in emergency situations. Excellent wear resistance and sealing performance, effective service life of more than 300,000 times. It is connected with the assembly by a live joint, which is convenient for maintenance and guarantees the sealing performance.

The master switch is controlled using a pedal. When using, just stand on the pedal, turn on the water inlet switch, turn on the eyewash switch when you need to wash your eyes, and turn on the shower switch when you need to shower. Leave the pedal after use, the water inlet switch is turned off, and at the same time, the system automatically switches to the emptying state, and the system automatically drains the water inside the eyewash pipe within 5 seconds.



WG7054A

### Composite self-draining emergency eyewash shower

Color	Eyewash flow speed (L/min)	Shower flow speed (L/min)	Water inlet	Water outlet	Product Dimensions (LxWxH/cm)	Package dimensions (LxWxH/cm)	Recommended water pressure /kPa	Standards / Certifications	Model
Stainless steel natural color	≥11.4	≥75.7	Rc 1" Height 60mm	Rc 1" Height 40mm	12×36×234	125×52×125	210	ANSI Z358.1-2014	<b>WG7054A</b>

## Wall Mounted Eye/Face Wash

- Application: Eye/Face wash for wall mounting. The bowl guides waste
- Materials: AES plastic + 304 Stainless Steel
- AES plastic has weather resistance properties and applies to indoors or outdoors
- With good acid-proof, alkali prevention performances, 304SS is ideal for harsh environment
- Activated by push handle easily
- The coin slot hidden faucet aerator is easy to remove and clean
- Dust cover is removed once unit started
- Comply with ANSI Z358.1-2014 and AS 4775-2007



WG7023



WG7023Y



WG7023G

### Wall Mounted Eye/Face Wash

Product	Main Material	Water Bowl		Flow Rate (L/min)	Inlet	Outlet	Pressure	Packing size LxWxH(cm)	Certification	Model
		Material	Diameter x Height (cm)							
Wall Mounted Eye/Face Wash	304 Stainless Steel	304 Stainless Steel	32×9.5	11.4	1/2"	1-1/4"	210kPa or 2.1bar or 30psi	37×37×14	ANSI Z358.1 AS 4775 CSA CE	<b>WG7023</b>
		AES plastic								<b>WG7023Y</b>
		304 Stainless Steel								<b>WG7023G</b>

## Pedestal Mounted Eye/Face Wash

- Materials: AES plastic + 304 Stainless Steel
- AES plastic has weather resistance properties and applies to indoors or outdoors
- With good acidproof, alkali prevention performances, 304SS is ideal for harsh environment
- Be activated by push handle or foot pedal easily
- The coin slot hidden faucet aerator is easy to remove and clean
- Dust cover is removed once unit started
- Comply with ANSI Z358.1-2014 and AS 4775-2007



WG7033F



WG7033FY



WG7033FG



WG7033P

### Pedestal Mounted Eye/Face Wash

Product	Main Material	Water Bowl		Flow Rate (L/min)	Inlet	Outlet	Pressure	Packing size LxWxH(cm)	Certification	Model
		Material	Diameter x Height (cm)							
Pedestal Mounted Eye/Face Wash	304 Stainless Steel	304Stainless Steel	32×9.5	11.4	1/2"	1"	210kPa OR 2.1bar OR30psi	95×35×26.5	ANSI Z358.1 AS 4775 CSA CE	WG7033F
		AESplastic	32×9.5			1"				WG7033FY
		304Stainless Steel	32×9.5			1"				WG7033FG
	ABS plastic	ABS plastic	30.5×8			1-1/4"		63×40.5×26		WG7033P

## Desktop faucet emergency eyewash station

This product comes with a faucet, which can be installed on the interface of a conventional faucet.

When using the eyewash function, just turn on the faucet switch, and clean water is automatically sprayed from the eyewash nozzle. The control valve body has a button for switching between eyewash and handwashing, which can be freely switched between the faucet and the eyewash.

impurities in the water  
a foamy water column, effectively preventing impurities in the water or secondary damage . The sprinkler is

equipped with a dust cover  
during use. Note that the dust cover must be reset after use.



WG7013

### Desktop faucet emergency eyewash station

Main material	Flow speed (L/min)	Water inlet size	Product Dimensions (LxWxH/cm)	Package dimensions (LxWxH/cm)	Model
Thickened copper electroplating	≥11.4	G1/2 internal thread	15×15×20	24×24×16	WG7013

## Drench Hose

Drench hose units, WG7011R & WG7012R are for deck mounting. Ideal for rinsing any part of user's eye, face or body. Under ANSI Z358.1-2014, drench hose units supplement, but do not replace, other types of emergency equipment.

- To meet the standard of Emergency Eyewash and Shower Equipment in ANSI Z358.1-2014 and AS4775-2007;
- Single or double spray head is optional, which has dust cover;
- Forged brass squeeze valve activated by plastic lever handle. Valve has replaceable stainless steel seat for exceptional durability. Valve closes when lever handle is released.

er

irrigate the eye;

210kPa (30psi);

the unit.



Drench Hose							
Name	Main Material	Color	Flow Speed (L/min)	Inlet & Outlet	Pressure (bar)	Packing size L*W*H/cm	Model
Drench Hose (Single)	Drench Hose (Single)	Red	6	G1/2"	3-6	27.4×19.6×15.6	<b>WG7011R</b>
Drench Hose (Double)	Drench Hose (Double)	Red	10	G1/2"	3-6	27.4×19.6×15.6	<b>WG7012R</b>

## Portable Eye Wash Station

- It adopts PE materials, and the production materials comply with the regulations of F.D.A on the grade on PE materials for food (F.D.A. Regulation on Polypropylene: the requirements of U.S.21 CFR F.D.A. Regulation Part 177.1520, portable containers clauses (C) for food contact use),and it is superior in its high intensity, good toughness, good Rigidity, heat and cold resistance
- It complies with human engineering principle in design, and adopts the law of gravity to produce water pressure and deliver water to two nozzles for eye washing
- It applies to work places without water supply and discharge red to provide timely and professional protection
- It complies with regulations of ANSI/ISEA on emergency eye wash station and showering equipment-ANSI Z358.1-2014
- It is suggested to discharge the liquid in eye wash station every two or four weeks or as required and clean every component of eye wash station



Portable Eye Wash Station								
Type	Main Material	Water Capacity (L/Gal)	Flow Speed (L/min)	Flushing Time(min)	Ext. size HxWxD(mm)	Packing size HxWxD(mm)	Certification	Model
Type A	PE	60/16	2.6	18	735x420x416	750×436×435	ANSI Z358.1 AS 4775 CE	<b>WG6000A</b>
Type B		30/8	2.6	9	625x350x342	635×357×360		<b>WG6000B</b>

## Portable Eyewash with Mobile Waste Cart

- Mobile waste cart adds portability and even holds the unit, also, collects waste water
- Perfectly equipped with WG6000A and WG6000B
- After placing on the cart, the spray heads are located , which comply with

ANSI Z358.1-2014

- Highly visible yellow, rugged polyethylene construction is well suited to long term use in harsh environments
- Built in handle for easy transport is great for use on remote site
- Petcock on the bottom for easy drainage
- Comes equipped with two rigid casters in front and two swivel casters with "Total Lock" brakes in back
- Includes clearly marked eyewash signs
- Cart has 37.5-gallon (142 liter) capacity and measures 86H x61.5W x 52D (cm)



WG6000AD

WG6000BD

WG005

### Portable Eyewash with Mobile Waste Cart

Main Material	Water Capacity(L/Gal)	Flow Speed(L/min)	Flushing Time(min)	Product Mix	Certification	Model
Poplyethylene	60/16	2.6	18	WG6000A+WG005	ANSI Z358.1 AS 4775 CE	<b>WG6000AD</b>
Poplyethylene	30/8	2.6	9	WG6000B+WG005		<b>WG6000BD</b>

### Mobile Waste Cart

Material	Capacity(Gal/L)	Ext.size(mm)H*W*D	Packing size(mm)H*W*D	Model
Poplyethylene	37.5/142	860×615×520	760×629×535	<b>WG005</b>

## Portable Sink

- High-quality 304 stainless steel frame; chamfered, polished smooth without edges and corners;
- High-quality 304 faucet and sink, the sink is integrally formed, beautiful and elegant;
- Front door, embedded handle, hidden magnetic attraction;
- The height of the sink and faucet is ergonomically designed, the pedal is built in, and it is easy to use;
- There are clean water buckets and sewage buckets inside, both of which are 20L standard plastic buckets;
- There is no need to connect the water inlet and drain pipes, it can be easily placed or moved, and is suitable for various scenarios.

## Eye Wash Sink

- . It is required that the installation site uld be done in time;
- The height of the sink and faucet is ergonomically designed and easy to use;
- The internal connection water pipes are all connected by hoses, and the connection joints with the water inlet pipe and the drain pipe are all standard parts;
- Use water pressure: not less than 210kPa (30psi, 2bar, 2.1Kgf/cm2 kgf/cm2);
- Water output: higher than the standard 1.5LPM (0.4GPM) requirement.



WGW0301

WGW0302

### Portable Sink

Product Name	Material	Inlet & Outlet	Recommended water pressure / kpa	External dimension L*W*H/cm	Package dimension L*W*H/cm	Model
Portable Sink	304 Stainless Steel	-	-	50x50x80	55x55x95	<b>WGW0301</b>

### Eye Wash Sink

Product Name	Material	Inlet & Outlet	Recommended water pressure / kpa	External dimension L*W*H/cm	Package dimension L*W*H/cm	Model
Eye Wash Sink	304 Stainless Steel	G1/2	210	50x50x80	55x55x95	<b>WGW0302</b>

## Explosion-proof electric heating emergency eyewash shower

The main material of the eyewash is made of 304 stainless steel, and the stainless steel has undergone pickling passivation treatment, which has stronger corrosion resistance to acid, alkali, salt, and oil chemicals.

The outer wall of the pipeline adopts a thermally conductive aluminum layer to wrap the electric heating cable on the outer wall of the eye washer pipeline, which effectively ensures that the heat of the electric heating cable is evenly conducted to all the pipeline surfaces of the eye washer. The heat loss of the heating cable is minimized, effectively ensuring that the eyewash pipe is in a constant temperature state. The temperature control system adopts a thermal resistance temperature controller, and the factory setting temperature is 35°C (adjustable temperature). When the temperature of the eyewash pipe is higher than 35°C, the electric heating cable will automatically cut off and stop heating. It forms a dual temperature control system with the self-limiting electric heating cable to ensure the safety of the equipment.

Equipped with leakage protection system, power indicator and working indicator at the same time.

The shell is made of new high-quality non-toxic ASA plastic, which has been treated with acid and alkali resistance and weather resistance, so it does not fade, does not age, has a long service life, and has excellent weather resistance. It will not affect its performance when used in an environment of minus 45 degrees. And it has the characteristics of anti-corrosion of chemical substances such as strong acid, alkali, salt, oil and so on. It is suitable for use outdoors and in some harsh environments.

An 80-mesh SS304 stainless steel can be installed at the water inlet to effectively impurities in the water, so as to avoid secondary damage to the eye nerves caused by impurities in the water.

### Explosion-proof electric heating emergency eyewash shower

Color	Power supply	Explosion-proof class	Protection class	Overall power	Product Dimensions (LxWxH/cm)	Package dimensions (LxWxH/cm)	Water inlet	Water outlet	Model
Yellow	220V AC 1PH 50HZ	Exd IICT6	IP65	200W	45×90×245	255×85×38	R1-1/4 External Screw pattern		<b>WG7054EX</b>



## Cable Heating Emergency Shower

Cable Heating Emergency Shower and Eyewash is the indoor/outdoor anti-freezing equipment with emergency rescue and primary processing. The unit can be used in -50°C. It consists of 304SS main pipe, heating cable, temperature controller, air safety layer, outer insulation layer and 304SS shell. Cable Heating Emergency Shower and Eyewash are manufactured according to standard CE-DIN12899-UN19608. When the chemicals or toxic substances splash to the staff body, face, eye or to staff clothing. The unit can quickly bring harm to a minimum. The soft rubber protecting cup can avoid second hurt resulted by colliding eyes when use it urgently. Standards Licensed to the internationally recognised standard ANSI Z358.1-2014 and are compliant with AS4775-2007 for Emergency Eyewash and Shower equipment.

### Cable Heating Emergency Shower

Main Material	Color	Flow Speed (L/min)	Inlet	Outlet	Pressure (bar)	Packing size L*W*H/cm	Model
304SS	Red	Eye:10L/min Shower:80L/min	from 1" to 1/2"	1"	3-6bar	230×70×30	<b>WG7054ER</b>



## Emergency Shower Room

Emergency Shower Rooms are manufactured according to standard CE-DIN12899-UN19608. When the chemicals or toxic substances splash to the staff body, face, eye or to staff clothing. The unit can quickly bring harm to a minimum. The soft rubber protecting cup can avoid second hurt resulted by colliding eyes when use it urgently. Standards Licensed to the internationally recognised standard ANSI Z358.1-2014 and are compliant with AS4775-2007 for Emergency Eyewash and Shower equipment.

### Emergency Shower Room

Main Material	Color	Flow Speed (L/min)	Inlet	Pressure (bar)	Packing size L*W*H/cm	Model
304SS	Silver	Eye:10L/min Shower:80L/min	from 1" to 1/2"	3-6bar	240×130×45	<b>WG7054H</b>

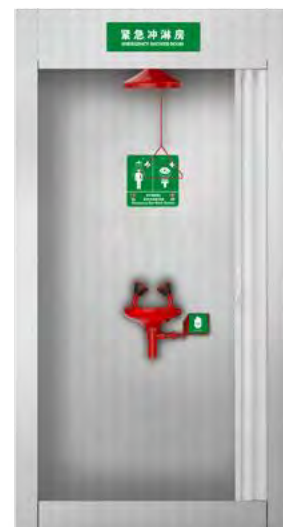

## Universal First aid product series

### Comprehensive Medical kit

- Model: SAC3466
- Included products: 27
- Size: 40×29×19cm



### Wall Mounted Metal First Aid Kit

- Model: WGA0201W
- Included products: 22
- Size: 38×25×12cm



### Wall Mounted Metal First Aid Kit (Glass door)

- Model: WGA0202W
- Included products: 22
- Size: 38×25×12cm



### Multipurpose first aid kit

- Model: SAC3464
- Included products: 27
- Size: 32×20×20cm



### Portable first aid kit

- Model: SAC5502
- Included products: 14
- Size: 21×15×7.5cm



### First Aid Travel Kit

- Model: SAC6136
- Included products: 9
- Size: 15×13×6cm





## School, Laboratory

### PP comprehensive first aid kit

- Model: SAC3942
- Included products: 29
- Size: 36×21×15cm



### Multi-layer storage first aid kit

- Model: SAC5995
- Included products: 23
- Size: 32×20×25cm



### Multifunctional first aid kit

- Model: SAC5530
- Included products: 29
- Size: 32×20×20cm



### ABS first aid kit

- Model: SAC3943
- Included products: 29
- Size: 31.5×21.5×12.5cm





## Emergency Reserve

### Family emergency supplies reserve package (Basic version)

- Model: SAC6279
- Included products: 26
- Size: 36×22×10cm



### Family emergency supplies reserve package (Expanded version)

- Model: SAC6278
- Included products: 38
- Size: 45×32×22cm

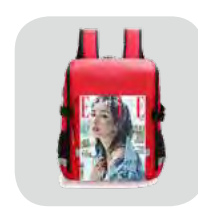

## Outdoor, T

### Car emergency first aid kit

- Model: SAC3467
- Included products: 24
- Size: 32×24×7cm



### Outdoor emergency rescue kit

- Model: SAC6109
- Included products: 24
- Size: 36×22×10cm



## AED

### NIHON KOHDDEN AED

- Model: SAC3603



## Wall Mounted First Aid Kit

- 2)It is made of steel, and powder-coat provides excellent chemical resistance.  
 3)There is handle for hand-carry conveniently, also can be fixed on the wall with screws. 4)Safety lock catch can make the door close tightly, avoid the dropping of drugs.



WGA0201W



WGA0202W



Wall Mounted First Aid Kit

Material	Ext dimension (H×W×D/cm)	Packing dimension (H×W×D/cm)	Carrying Method	Model
steel	38×25×12	40×26×13	Wall-Mounted/ Portable	<b>WGA0201W</b>
steel	38×25×12	40×26.4×13.5	Wall-Mounted	<b>WGA0202W</b>

Supplementary Set WGA0201W-2

Material name	Quantity
Spandex original white plain weave bandage (75g)	2
Emergency blanket	1
Triangle scarf, 90cm*90cm*130cm	1
Burn dressing	2
Safety pin	10
tweezers	1
Disposable disinfection tablets	20
Medical tape	1
Snap-in tourniquet	2
First aid scissors	1
Polymer emergency splint	1
	1
First aid instructions	1
First aid manual	1
First aid whistle	1
Disposable medical iodophor cotton swab	20
0.9% saline cleaning solution (15ml)	4
	2
membrane (CPR)	1 pack of 10
Disposable protective mask	2
Chemical ice pack	2 packs of 20
Disinfection wipes	2
Hand sanitizer	2

## Safety Spectacles

Used to prevent the impact of high-speed particles. The anti-fog and ultraviolet-proof characteristics help to reduce the risk of fog and to ensure eye safety.

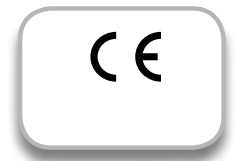

WG-7228



WG-7280



WG-7253



WG-7256

### Safety Spectacles

Certification	Color of optic-catio	Optic material-catio	Antifo-gging	Ultraviolet-proo	Heated temperature	leg of glasses	Features	Model
CE	Transparent	PC	✓	✓	~5-55		Adjustment leg of glasses and bayonet design	<b>WG-7228</b>
			✓	✓	~5-55	Assembled frame, Lateral wing, eyebrow, and guard frame are in the integration	Assembled frame, Lateral wing, eyebrow, and guard frame are in the integration. Optic and frame are designed integrally. It has ventilated lateral wing and no metal accessories. Corrective glasses can be wore inside and it can be used as visiting glasses.	<b>WG-7280</b>
			✓	✓	~5-55	A soft leg of glasses that can rotate up and down.	Adjustment leg of glasses and bayonet design. Unique soft nose beam support.	<b>WG-7253</b>
			✓	✓	~5-55	A soft leg of glasses. can rotate leg of glasses.3-rotate leg of glasses.	A soft leg of glasses and unique soft nose beam support.	<b>WG-7256</b>

## Safety Goggles

To prevent from the splashing of chemical liquid. The frame adopts indirect vent design to effectively reduce dust entry and ensure eye safety.



WG-9200

### Safety Goggles

Certification	Color of optic-catio	Optic material-catio	Antifo-gging	Ultraviolet-proo	Heated temperature	leg of glasses	Features	Model
CE	Transparent	PC	✓	✓	~5-55	N/A	Fit closely with face. Anti-chemical, impact-resistant and corrective glasses can be worn inside.	<b>WG-9200</b>

## Chemical label

Used for the logo of dangerous items, inform people of the category of the items to prevent accidents.



**explosive  
(GHS)**



**Non-flammable  
non-toxic gas  
(GHS)**



**Corrosive  
substances  
(GHS)**



**aquatic toxicity  
(GHS)**



**oxide  
(GHS)**



**flammable  
substances  
(GHS)**



**Toxic Chemicals  
(GHS)**



**harmful materials  
(GHS)**



**carcinogenic  
substances  
(GHS)**

### WL019

GHS Combination Label	Quantity	Model
explosive Corrosive substances aquatic toxicity Toxic Chemicals	10 piece	<b>WL019</b>

3M610Adhesive



### Chemical Labels - GHS Labels

GHS label	Quantity	Model
explosive	10 piece	<b>WL001</b>
		<b>WL002</b>
Corrosive substances		<b>WL003</b>
aquatic toxicity		<b>WL004</b>
oxide		<b>WL005</b>
		<b>WL006</b>
Toxic Chemicals		<b>WL007</b>
harmful materials		<b>WL008</b>
carcinogenic substances		<b>WL009</b>

3M610Adhesive

# Total Solution of the Lab Industry



*\*Please contact SYSBEL for more solutions*



# Total Solution of Chemical Management in Industry



*\*Please contact SYSBEL for more solutions*

# Regulation Abstract

Safety Storage Cabinet

Storage Container

Spill Prevention Containment

& Control System



## OSHA 29 CFR 1910.106

### OSHA 29 CFR 1910.106(a)(19)

Flammable liquid means any liquid having a flashpoint at or below 199.4 °F (93 °C). Flammable liquids are divided into four categories as follows:

1910.106(a)(19)(i, ii, iii, iv & v)

Category 1 shall include liquids having a flashpoint below 73.4 °F (23 °C) and having a boiling point at or below 95 °F (35 °C). Category 2 shall include liquids having a flashpoint below 73.4 °F (23 °C) and having a boiling point above 95 °F (35 °C). Category 3 shall include liquids having a flashpoint at or above 73.4 °F (23 °C) and at or below 140 °F (60 °C). When a Category 3 liquid with a flashpoint at or above 100 °F (37.8 °C) is heated for use to within 30 °F (16.7 °C) of its flashpoint it shall be handled in accordance with the requirements for a Category 3 liquid with a flashpoint below 100 °F (37.8 °C). Category 4 shall include liquids having a flashpoint at or above 140 °F (60 °C) and at or below 199.4 °F (93 °C). When a Category 4 liquid is heated for use to within 30 °F (16.7 °C) of its flashpoint it shall be handled in accordance with the requirements for a Category 3 liquid with a flashpoint at or above 100 °F (37.8 °C). When liquid with a flashpoint greater than 199.4 °F (93 °C) is heated for use to within 30 °F (16.7 °C) of its flashpoint it shall be

### OSHA 29 CFR 1910.106(d)(3)

"Design, construction, and capacity of storage cabinets" -

1910.106(d)(3)(i)

"Maximum capacity." Not more than 60 gallons of Category 1, 2, or 3 flammable liquids, nor more than 120 gallons of Category 4

1910.106(d)(3)(ii)

"Fire resistance." Storage cabinets shall be designed and constructed to limit the internal temperature to not more than 325 deg. F. when subjected to a 10-minute test using the standard time-temperature curve as set forth in Standard Methods of Fire Tests of Building Construction and Materials, NFPA 251-1969, which is incorporated by reference as specified in Sec. 1910.6. All joints and seams shall remain tight and the door shall remain securely closed during the test. Cabinets shall be labeled in conspicuous lettering, "Flammable - Keep Fire Away."

1910.106(d)(3)(ii)(a)

Metal cabinets constructed in the following manner shall be deemed to be in compliance. The bottom, top, door, and sides of cabinet shall be at least No. 18 gage sheet iron and double walled with 1 1/2 - inch air space. Joints shall be riveted, welded or made tight by some equally effective means. The door shall be provided with a three-point lock, and the door sill shall be raised at least 2 inches above the bottom of the cabinet.

1910.106(d)(3)(ii)(b)

Wooden cabinets constructed in the following manner shall be deemed in compliance. The bottom, sides, and top shall be constructed of an approved grade of plywood at least 1 inch in thickness, which shall not break down or delaminate under test conditions. All joints shall be rabbetted and shall be fastened in two directions with wood screws. When more than one door is used, there shall be a rabbetted overlap of not less than 1 inch. Hinges shall be mounted in such a manner as not to lose their holding capacity due to

### OSHA 29 CFR 1910.106 (a)(29)

Safety can shall mean an approved container, of not more than 5 gallons capacity, having a spring-closing lid and spout cover and so designed that it will safely

### OSHA 29 CFR 1910.125(e)(4)(ii&(iii))

Rags and other material contaminated with liquids from dipping or coating operations are placed in approved waste cans immediately after use; and waste can contents are properly disposed of at the end of each shift.

### OSHA 29 CFR 1910.144(a)(1)(ii)

Danger. Safety cans or other portable containers of flammable liquids having a flashpoint at or below 80°F, table top containers of flammable liquids (open cup tester), excluding shipping containers, shall be painted red with some conspicuous yellow band around the can or the name of the contents conspicuously stenciled or painted on the can in yellow. Red lights shall be provided at barricades and at temporary obstructions. Danger signs shall be painted red.

### NFPA CODE 30 2012 Edition FLAMMABLE AND COMBUSTIBLE LIQUIDS CODE

9.5 Flammable Liquids Storage Cabinets.

9.5.1 The volume of Class I, Class II, and Class IIIA liquids stored in an individual storage cabinet shall not exceed 120 gal (460 L)

9.5.2 The total aggregate volume of Class I, Class II, and Class IIIA liquids in a group of storage cabinets shall not exceed the maximum allowable quantity of flammable and combustible liquids per control area based on the occupancy where the cabinets are located.

9.5.4.1 If a storage cabinet is not ventilated, the vent openings shall be sealed with the bungs supplied with the

### EPA 40 CFR 264.175:

Containment. (a) Container storage areas must have a containment system that is designed and operated in accordance with paragraph (b) of this section, except as otherwise provided by paragraph (c) of this section.

(b) A containment system must be designed and operated as follows:

(3) The containment system must have sufficient capacity to contain 10% of the volume of containers or the volume of the largest container, whichever is greater. Containers that do not contain free liquids need not be considered in this determination.

### Spill Prevention, Control and Countermeasures (SPCC) Compliant

What is SPCC and who is regulated by the rule? SPCC is short for Spill Prevention Control and Countermeasures. The rule was developed under the authority of The Federal Water Pollution Control Act and The Clean Water Act, and is designed to prevent oil pollution in US waterways. The SPCC Rule outlines the requirement of owners and operators of on shore facilities and offshore facilities to prepare and implement a Spill Prevention Control and Countermeasures plan.

Application to spill control products, The SPCC Rule outlines the requirement of an owner and operator to demonstrate in their SPCC plans considerations for secondary containment solutions for containers 55 gallons and larger. Each secondary containment shall be as follows:

1) To hold the entire capacity of the largest container.

2) T

Notes:

2) Adequate freeboard needs to be determined by the owner, or the operator or their engineer as outlined in their plan.

3) Pallets that are sheltered do not require freeboard to hold precipitation. This would be implied under "good engineering practices."

### ANSI Z358.1-2014 Standards for Emergency Eyewash and Shower Equipment:

(1) Specifying the minimum performance and operation requirements of emergency eyewash and shower equipment;

## SYSBEL Safety Cabinet Dimensions

Storage Cabinet Model	Color Classification	capaci- ty /Gal	capaci- ty /L	Dimensions H×W×D(cm)	Internal dimen- sions H×W×D(cm)	Standard layer plate	Snap spacing (cm)
WA810040 / WA810041 / WA810042R / WA810040B	yellow, yellow, red, blue	4	15	56x43x43	46x35x35	1	/
WA0810080	yellow	8	30	61.5x56x52	51x48x43.5	1	7.6
WA0810080T	yellow	8	30	61.5x56x52	37x43x42	/	/
WA810100	yellow	10	38	64x59x60	54x51x52	1	/
WA0810100	yellow	10	38	61.5x71x52	51x63x43.5	1	7.6
WA810120 / WA810121 / WA810122 / WA810120B / WA810120W / WA810120V / WA810120G / WA810125B	yellow, yellow, red, blue, white, white, green	12	45	89x59x46	79x51x38	1	7.6
WA3810120	yellow	12	45	46x109x46	36x101x38	-	7.6
WA0810140	yellow	14	53	61.5x86x52	51x78x43.5	1	7.6
WA810150	yellow	15	57	112x59x46	102x51x38	-	7.6
WA031050	Cabinet yellow, cabinet door yellow, white, blue	15	57	184.5x43x46	56.5x35x37.5	3	7.6
WA3810170 / WA810170	yellow, yellow,	17	64	61x109x46	51x101x38	1	7.6
WA0810180	yellow	18	68	79x75x56	69x67x47.5	1	7.6
WA0810190	yellow	19	72	91x76x57	81x67x46	1	7.6
WA810220 / WA810221 / WA810220B	yellow, yellow, blue	22	83	165x60x46	154x52x38	3	7.6
WA0810230	yellow	23	87	89x89x55	79x80x48	1	7.6
WA810300 / WA810301 / WA810300R / WA810300W / WA810305B	yellow, yellow, red, blue, blue	30	114	112x109x46	102x101x38	1	7.6
WA810300C	yellow	30	114	112x109x46	102x102x47	1	7.6
WA032050	Cabinet yellow, cabinet door yellow, white, blue	30	113	184.5x86x46	56.5x38.5x37.5	6	7.6
WA810450 / WA810451 / WA810452 / WA810450B / WA810450W / WA810452W / WA810455W / WA810450G / WA810453B / WA810455B	yellow, yellow, red, blue, white, white, white, green, blue, blue	45	170	165x109x46	155x101x38	2	7.6
WA810450 / WA810450L / WA810450LB / WA810450LB / WA810450W / WA810450LW	yellow, yellow, blue, blue, white, white	45	170	186x109x46	155x101x38	2	7.6
WA810454	blue	45	170	189x109x46	155x101x38	4	7.6
WA033050	Cabinet yellow, cabinet door yellow, white, blue	45	170	184.5x129x46	56.5x40x37.5	9	7.6
WA810530	yellow	45	170	180x109x46	170x101x38	2	7.6
WA810540 / WA810541	yellow, yellow	54	204	165x60x87	155x52x79	3	7.6
WA810550	yellow	55	207	165x86x86	155x78x78	1	7.6
WA810600 / WA810601 / WA810600R / WA810600B	yellow, yellow, red, blue	60	227	165x86x86	155x78x78	2	7.6
WA810860 / WA810861 / WA810860R / WA810860B	yellow, yellow, red, blue	90	340	165x109x86	155x101x78	2	7.6
WA811100	yellow	110	415	165x150x86	155x142x78	1	7.6
WA810115	yellow	115	434	165x150x86	155x142x78	2	7.6
SE490100	yellow	10	38	61.5x56x52	/	1	3.2
SE490120	yellow	12	45	75x60x52	/	1	3.2
SE490170	yellow	17	64	61.5x86x52	/	1	3.2
SE490190	yellow	19	72	63x110x59	/	1	3.2
SE890230/SE860230	yellow	23	87	204x60x62.5	/	3	3.2
SE490300	yellow	30	114	204x90x62.5	/	3	3.2
SE830450/SE890450	yellow	45	170	204x116x62.5	/	3	3.2
ACP810001	Polyethylene material	4	15	49x41x36	44x38.5x30.5	1	-
ACP810004	white PP material	4	15	59x46x43	55x44x36	1	8
ACP810012 / ACP810012GA	white PP material	12	45	89x59x46	82x57x39	1	8
ACP820012	Polyethylene material	12	45	89x53x55	85x48x48	2	-
ACP810002	Polyethylene material	22	83	89x90.5x54.5	76x89x49.5	4	-
ACP810022	white PP material	22	83	165x59x46	158x57x39	2	8
ACP810024	white PP material	24	90	89x59x46	82x57x39	1	8
ACP810025	white PP material	25	90	180x59x46	41*57*37	-	-
ACP810030	white PP material	30	114	112x109x46	105x107x39	1	8
ACP810040	white PP material	40	150	180x90x46	left 41x46x37 right 41x40x37	-	-
ACP810048 / ACP810048T	white PP material	48	180	180x109x46	upper layer 81x107x42 lower level 83x107x42	2	8



## SYSBEL Eyewash selection table (By usage environment)

Eye Wash Type	Material	ANSI Standard Speed (L/Minute)	Main Character	Use Under Environment					
				Type	Workplace without water supply	Workshop /Lab	Workplace that eye on the wall	Eye and face wash	Eye/face and body wash
Portable Eye Wash Station	Polyethylene	1.5	Only have eye wash nozzle; suitable for outdoor or workplace without water supply.No installation requirements. With the cart which is convenient to ferent requirements	Portable	√			√	
Wall Mounted Eyewash(No Bowl)	Stainless Steel	11.4	so that the space will be saved.	Static		√		√	
Wall Mounted Eyewash (With Bowl)	Stainless Steel	11.4		Static		√		√	
Combination Units (With Bowl)	Stainless Steel	11.4 eyewash 75.6 shower	With eye wash nozzle and shower system; Eye wash is used for cleaning chemical spray on the eyes/face; Shower is used for cleaning chemical spray on the body.	Static		√	√	√	√
Eyewash Drench Wash	PE STEEL COPPER	11.4	Eyewash Drench Wash: suitable for indoor tank water	Static		√	√	√	√

### Remark:

- Comply with the provisions of the American National Standards Institute/Industrial Safety Equipment Association on emergency eyewash and shower equipment ANSI Z358.1-2014, Australian standard AS 4775-2007, national standard GB/T 38144
- There are five categories of eyewash products, including 4 portable eyewashes, 3 wall-mounted steel eyewashes; 4 vertical steel eyewashes; 6 emergency showers; 6 composite eyewashes
- The product models are:  
Portable (PE): WG6000A WG6000B  
WG6000AD  
WG6000BD  
Wall Mount: WG7023 WG7023Y WG7023G  
Vertical: WG7033FY WG7033F WG7033FG WG7033P  
Composite: WG7053F WG7053FY WG7053FG WG7053P  
Handheld: WG7011R WG7012R
- In an environment with too high acidity, it is recommended to use an eyewash made of 304 stainless steel + electrostatic powder coating, or an ABS eyewash
- For areas with mild climate environment, you can choose to place the steel series eyewash for outdoor use; the AES plastic selected for sprinklers, basin showers, etc. has strong weather resistance, or use ABS eyewash



## SYSBEL Absorbent Material Selection Guide

**Disclaimer:** The following information is only as a guide, it does not guarantee the absolute accuracy. All the data are based on ambient temperature and pressure, the chemical substance is under the norm circumstances, rather than a mixture or combination. We recommend you to conduct a small test prior to the application of SYSBEL adsorbent materials about their pending chemical compatibility and absorption effect, to ensure application security.

**Waste Disposal:** Unused polypropylene adsorbent material can be regarded as a common waste disposal in Cotton pollutants after adsorption of chemical liquid or hazardous materials shall be properly transferred to a chemical disposal bag or bucket with SYSBEL spill response package. They should be transferred to a professional waste disposal organization according to local regulations.

Chemicals	Oil Only Polypropylene	Universal and Hazmat Polypropylene
Acetaldehyde		•
Acetic Acid	•	
Acetic Anhydride		•
Acetone	•	•
Acetyl Bromide	•	•
Acetyl Chloride		•
Acrolein	•	
Acrylonitrile		•
Acrylic Acid		•
Acrylic Emulsions		•
Allyl Alcohol		•
Allyl Chloride	•	
Aluminum Hydroxide		•
Aminobenzoic Acid		•
Ammonia (Anhydrous)	•	•
Ammonium Hydroxide	•	•
Amyl Acetate	•	•
Amyl Alcohol		•
Aniline		•
Aqua Regia		•
Arsenic Trichloride		•
Aviation Fuel	•	•
Barium Hydroxide		•
Benzene	•	•
Benzoic Acid		•
Benzonitrile		•
Benzol Chloride		•
Benzyl Chloride		•
Benzyl Alcohol		•
Boric Acid		•
Brake Fluid	•	•
Bromine		•
Butyl Acetate	•	•
Butyl Alcohol	•	•
Butyl Phthalate		•
Butyric Acid	•	•
Butylamine		•
Butyric Acid	•	•
Calcium Hydroxide		•
Calcium Hypochlorite		•
Carbolic Acid		•
		•
Carbon Tetrachloride	•	•
Castor Oil	•	•
Chlorine Water		•
Chloroacetic Acid		•
Chlorobenzene		•
Chlordane		•
Chloroform	•	•
Chromic Acid (50%)		•
Chlorosulfonic Acid		•
Citric Acid		•
Clorox (Full Strength Bleach)		•
Corn Oil	•	•
Cottonseed Oil	•	•
Cresol	•	•
Cyclohexane	•	•
Detergents		•
Diazinon		•
Dichlorobenzene	•	•
Dichloropropane		•
Dichloropropene		•
Diethylamine	•	•
Diethyl Ether	•	•
Disooctyl Phthalate	•	•
Disulfoton		•
Dinitrobenzene	•	•
Dioxan		•
Ehtion		•
Epichlorohydrin		•
Ether	•	•
Ethyl Acetate	•	•
Ethyl Alcohol	•	•
Ethyl Benzene	•	•
Ethyl Chloride	•	•
Ethyl Ether	•	•
Ethyl Propionate	•	•
Ethylene Dibromide		•
Ethylene Dichloride		•
Ethylene Glycol		•
Ethylenediamine		•
Formaldehyde		•
Formic Acid		•
Fuel Oil	•	•
Furfural		•
Gasoline	•	•
Gearbox Oil	•	•
Glacial Acetic Acid		•
Glycerol		•

Chemicals	Oil Only Polypropylene	Universal and Hazmat Polypropylene
Heptane	•	•
Hexane	•	•
Hydrazine		•
Hydrochloric Acid		•
Acid		•
Hydrogen Cyanide	•	•
Hydrogen Peroxide		•
Isobutyl Alcohol	•	•
Isobutyric Acid	•	•
Isoprene	•	•
Isopropyl Acetate	•	•
Isopropyl Alcohol	•	•
Kerosene	•	•
Keytones	•	•
Linseed Oil	•	•
Lubricating Oil	•	•
Magnesium Hydroxide		•
Malathion		•
Methyl Alcohol	•	•
Methyl Chloride	•	•
Methyl Ether		•
Methyl Ethyl Ketone	•	•
Methyl Methacrylate	•	•
Methyl Propionate	•	•
Mevinphos		•
Mineral Oil	•	•
Monoethylamine		•
Monomethylamine		•
Motor Oil	•	•
Naphthalene	•	•
Nitric Acid		•
Nitrobenzene		•
Nitrobenzoic Acid		•
Nitrotoluene	•	•
Octane	•	•
Oleic Acid	•	•
Olive Oil	•	•
		•
Parathion		•
Perchloroethylene	•	•
Petroleum Ether	•	•
Phenol		•
Phosphorous Oxychloride		•
Phosphorous Trichloride		•
Phosphoric Acid		•
Plating Solutions		•
Polychlorinated Biphenyls		•
Potassium Hydroxide		•
Propanol		•
Propionic Acid	•	•
Propionic Anhydride		•
Propyl Alcohol	•	•
Propylene Glycol	•	•
Propylene Oxide		•
Pyrethrins		•
Quinoline		•
Resorcinol		•
Salt Solutions (Metallic)		•
Silicone Oil	•	•
Silver Nitrate		•
Soap Solution (Concentrated)	•	•
Sodium Bicarbonate		•
Sodium Chloride		•
Sodium Hydroxide		•
Sodium Hypochlorite		•
Sodium Nitrate		•
Stannic Chloride		•
Starch		•
Styrene	•	•
Sucrose		•
Sulfur Monochloride		•
Sulfuric Acid		•
Synthetic Motor Oil	•	•
Tannic Acid		•
Tetraethyllead		•
Tetraethylpyrophosphate		•
Toluene	•	•
Transformer Oil	•	•
Trichloroethylene	•	•
Triethylamine		•
Triethylene Glycol	•	•
Trimethylamine		•
Turpentine	•	•
Urine		•
Vinyl Acetate	•	•
Vinegar		•
Vinylidene Chloride		•
Xylene	•	•

## User's Guide for SYSBEL Polyethylene Products

Substance	Concentration	Character
Acetic acid, Glacial	100°C	strongly corrosive amicable
Acetic acid, aqueous	80°C	strongly corrosive amicable
Acetic acid, aqueous	70°C	amicable
Acetic acid, aqueous	30-60°C	amicable
Acetic acid, aqueous	20-30°C	amicable
Acetic acid, aqueous	10-20°C	amicable
Acetic acid, aqueous	0-10°C	corrosive
Acetic acid+acetic acid	90 : 10	amicable, toxic
Acetic anhydride		amicable
Adipic Acid		corrosive, combustible
Acids, aromatic		corrosive
Aluminum chloride, anhydrous	any	corrosive, irritant
Ammonium sulphide, aqueous	any	amicable
Aqua regia (HCl+HNO <sub>3</sub> )		strongly corrosive
		corrosive
Benzene sulphonic acid		corrosive, irritant
Bromic acid	conc.	corrosive, irritant
Bromine (liquid)		corrosive, toxic
Butyric acid	any	corrosive
Carbolic acid		corrosive, combustible
Chloroacetic acid, aqueous	≤85%	corrosive, combustible
Chloric Acid 20% 20%	20%	strong acid, corrosive
Chlorine water 2%	2%	corrosive, irritant
Chlorine Water Saturated	Saturated	corrosive, irritant
Chloroform		very humful, toxic
Carbolium	as supplied commerc.	corrosive
Chlorosulphonic acid	techn. grade	corrosive, irritant
Chromic acid		corrosive
Chlorine, liquid		toxic, corrosive, flammable, irritant
Citric Acid		corrosive, combustible
Cresylic Acid		toxic, corrosive
Diglycolic Acid, aqueous		irritant
Decahydronaphthalene (Dekalin)		humful, corrosive
Ethylenediamine	techn. grade	humful, corrosive amicable
1, 2-Dibromoethane 1,2		toxic
Dibutyl ether		
Dextrin		
Dextrose		
Dichloromethane		humful, irritant
Dichloropropene		
Dichloroacetic acid	techn. grade	corrosive, toxic
Dichloroacetic acid	50%	corrosive, toxic
Dichloroacetic acid methyl ester		irritant, combustible
Ethylenediamine tetraacetic acid		irritant, combustible
Ethyl acetate (acetic acid ethyl ester)		amicable, toxic
Fatty acids (> C6)		
Fluoroboric Acid		corrosive, irritant
Fluorosilicic Acid		corrosive, toxic
Foric Acid		corrosive
Formic acid, aqueous	10%	corrosive
Formic acid, aqueous	25%	corrosive
Formic acid, aqueous	50%	corrosive, combustible
Formic acid, aqueous	100%	corrosive, combustible
Gallic Acid		irritant
Glacial acetic acid (100% acetic acid)		strongly corrosive amicable
Glycolic Acid	30%	corrosive
Glycolic Acid	up to 70%	corrosive
Hydrobromic Acid	20%	corrosive, irritant
HCl (hydrochloric acid)	10%	corrosive
HCl (hydrochloric acid)	48%	corrosive
HCl (hydrochloric acid)	any	corrosive
Acid	4%	corrosive
Acid	10%	corrosive
Acid	48%	corrosive
Acid	60%	corrosive
Acid		corrosive
HNO <sub>3</sub> (nitric acid)	25%	strong acid, corrosive
HNO <sub>3</sub> (nitric acid)	50%	strong acid, corrosive
HNO <sub>3</sub> (nitric acid)	95%	strong acid, corrosive
HClO <sub>4</sub> (perchloric acid)	20%	strong acid, corrosive

Substance	Concentration	Character
HClO <sub>4</sub> (perchloric acid)	50%	strong acid, corrosive
HClO <sub>4</sub> (perchloric acid)	70%	strong acid, corrosive
H <sub>2</sub> SO <sub>4</sub> (sulfuric acid)	up to 50%	strong acid, corrosive
H <sub>2</sub> SO <sub>4</sub> (sulfuric acid)	70%	strong acid, corrosive
H <sub>2</sub> SO <sub>4</sub> (sulfuric acid)	80%	strong acid, corrosive
H <sub>2</sub> SO <sub>4</sub> (sulfuric acid)	98%	strong acid, corrosive
Hydrogen peroxide, aqueous	10%	humful, corrosive
Hydrogen peroxide, aqueous	30%	humful, corrosive
Hydrogen peroxide, aqueous	100%	humful, corrosive
Hypochlorous acid		corrosive, irritant
Isobutyric acid		corrosive, humful amicable
Lactic acid, aqueous DL		corrosive, irritant
Maleic Acid, Aqueous	up to 100%	humful
Malic acid, aqueous	50%	irritant, combustible
Methacrylic acid		
Methyl Acetate		
Nicotine Acid		irritant
Oleic Acid		irritant, combustible
Oleum		corrosive
Oxalic Acid		corrosive, combustible
Palmitic acid		irritant
Perchloric acid	10%	corrosive, irritant
Perchloric acid	70%	corrosive, irritant
Peracetic Acid	40%	corrosive, amicable
Phosphoric Acid	0-25%	corrosive
Phosphoric Acid	25-50%	corrosive
Phosphoric Acid	50-90%	corrosive
Picric Acid		
Salicylic Acid		humful
Selenic acid		corrosive, toxic
Silicic Acid		corrosive, irritant
		irritant, combustible
Stearic acid		irritant
Sulphurous acid		corrosive, combustible
Succinic acid, aqueous	50%	corrosive, combustible
Tannic acid		irritant
Tartaric Acid		irritant
Thioglycolic acid		very toxic, corrosive
Thionyl Chloride		corrosive
Titanium(III)chloride solution	typically 20%	corrosive
Tin(II)chloride		corrosive, toxic
Tin(IV)chloride		corrosive, toxic
Tributyl Phosphate		humful
Triethylamine		corrosive, humful
Uric acid		irritant
Fuming sulphuric acid	trace	highly corrosive
Sodium hydroxide, aqueous	any	corrosive, strong bases
KOH (potassium hydroxide)	any	corrosive, strong bases
Ca(OH) <sub>2</sub> (calcium hydroxide)	any	corrosive, strong bases

P.S. 1) corrosive; strongly corrosive; strong acid;  
strong bases; humful; very humful;  
2) irritant; toxic; combustible.



corrosive  
strongly corrosive  
strong acid  
strong bases



toxic  
humful  
irritant



combustible

Please contact the nearest distributor

### **ALASDAF Trading Est.**



!Tel. : + (966) 13 362 3921  
!Fax : + (966) 13 362 0984  
!P.O. Box 42, Al-Jubail 31951  
King Fahad Street  
!Kingdom of Saudi Arabia  
!Email: [alasdaf@al-asdaf.com](mailto:alasdaf@al-asdaf.com)  
!Website: [www.alasdaf.com.sa](http://www.alasdaf.com.sa)

### **SYSBEL IS SAFETY**

Customers are the core of **SYSBEL**, as well as the definers of our service and product quality. **SYSBEL** attaches great importance to customers' feedback and experience. Customers' satisfaction is crucial to us, because if we fail, others will make it.

